

# Surgical and Safety

---

SOLUTIONS



Since 1973, DeRoyal Industries, Inc. has been committed to improving the clinical quality and economic health of its customers.

**Contact us at:**

[customerservice@deroyal.com](mailto:customerservice@deroyal.com)

or

888.938.7828/865.938.7828

 DeRoyal®



# Table of Contents

## TEMPERATURE MONITORING

Temple Touch Pro™ Non-Invasive Core Temperature Device	1
Interface Cables	2
Core Temperature	3 - 7
Skin Surface Temperature	8
Neonatal	9 - 12

## WASTE FLUID MANAGEMENT

Suction Canisters	13 - 15
Suction Tubing, Handles, & Connectors	16 - 19
Solidifier	20
Specialty Fluid Control	21 - 24
Suction Hardware & Accessories	25 - 29

## SURGICAL PATIENT POSITIONERS

Head & Neck	30 - 32
Upper Extremity	33 - 34
Lower Extremity	35 - 41
OR Table Pads & Accessories	42 - 44
Body Aligners	45
Multi-Angle Patient Positioning System	46 - 47
Positioning Kits	48 - 52

## ELECTROSURGICAL

Electrosurgical Pencils	53
Electrodes, Specialty Electrodes, & Dispersive Electrodes	54 - 55
Electrosurgical Accessories	56
Smoke Evacuation	57

## ENDOSCOPIC AND LAPAROSCOPIC

Insufflation	58 - 59
Laparoscopic	60 - 63

## SPECIALTY SPONGES

Miscellaneous Sponges	64
Ophthalmic Sponges & Eye Spears	65
Dissecting Sponges	66 - 67
Tonsil & Adenoid Sponges	68
Surgical Gauze Sponges	69
Sterile Cotton Balls	70
Miscellaneous Sponges	71
Neurology Sponges	72
Laparotomy Gauze Sponges	73
Packing	74
Sponge Counter Bag	75
OR Towels	76 - 77

# Table of Contents

## **SURGICAL ACCESSORIES**

Vessel Loops . . . . .	78
Light Handle Covers . . . . .	79
Skin Staplers . . . . .	80
Surgical/Utility Markers . . . . .	81 - 82
Suture Boots . . . . .	83
Instrument Pads, Pouches, & Wipes . . . . .	84 - 85
Holders & Clamps . . . . .	86 - 87
Equipment Covers & Drapes . . . . .	88 - 94
Bandages, Cast Padding/Stockinette . . . . .	95 - 98
Suspension Kits . . . . .	99 - 100

## **SAFETY SOLUTIONS**

Facial Protection . . . . .	101 - 102
OR Safety Management . . . . .	103 - 106

## **LABOR AND DELIVERY**

Basin Sets . . . . .	107 - 108
Labor & Delivery Essentials . . . . .	109 - 110
Labor Facilitation . . . . .	111
Newborn Essentials . . . . .	112 - 113
Enteral Safe Feeding . . . . .	114 - 115
Blood Pressure Cuffs . . . . .	116
Phototherapy Masks . . . . .	117
Warming Devices . . . . .	118
Armboards . . . . .	119
Footprinters . . . . .	120
Circumcision Products . . . . .	121 - 122
Trademark Attributions . . . . .	123

# Temperature Monitoring

## Temple Touch Pro™ Non-Invasive Core Temperature Device

### Temple Touch Pro™ System

- Non-Invasive core temperature sensor minimizes the risk of infections and complications that might be generated from the use of invasive probes
- Enables continuous and accurate temperature monitoring throughout diverse clinical settings (Pre-Op, OR, PACU, and ICU) and all anesthesia types (general, local, and regional)
- Proven to track and reflect changes in body temperature faster than invasive probes
- Easy to place sensors mitigate interference with other sensors (EEG), the hairline, and the eyebrows
- Disposable sensor unit can be applied for up to 24 hours
- Clip provided to secure cable to patient gown
- Core body temperature displayed on Monitor Connecting Unit (MCU) and patient monitor
- Compatible with most multi-functional monitors and EMR systems
- Indicated for use on patients of all ages
- Reference Units available to check MCU accuracy
- Non-sterile



Product #	Description	Size	Qty
81-1020SU	Temple Touch Pro™ Sensor Unit	2" x 0.7" x 0.2"	50/Cs
81-1020TTP	Temple Touch Pro™ Kit Includes: Monitor Connecting Unit Sensor Connecting Unit (81-1020SCU) USB Power Cable (81-1020PC) AC/DC USB Adapter, US Plug (81-1020A*)	—	1 Ea
81-1020SCU	Sensor Connecting Unit	9' Length	1 Ea
81-1020REF	Temple Touch Pro™ Reference Units*	—	1 Ea
81-1020SM*	Interface Cable, Siemens®/Dreager®, 400 Series	11.8" Length	1 Ea
81-1020HP *	Interface Cable, HP®/Philips®, 400 Series	11.8" Length	1 Ea
81-1020MR *	Interface Cable, Mindray®, 400 Series	11.8" Length	1 Ea
81-1020400	Interface Cable, ¼" Pin, 400 Series	11.8" Length	1 Ea
81-1020GE *	Interface Cable, GE®/Marquette™, 400 Series	11.8" Length	1 Ea
81-1020SL *	Interface Cable, SpaceLabs™, 400 Series	11.8" Length	1 Ea
81-1020PC	USB Power Cable	10' Length	1 Ea
81-1020A *	AC/DC USB Adapter, US Plug	—	1 Ea

 \*WARNING- This product can expose you to chemicals including Lead, which is known to the State or California to cause cancer, and Lead, which is known to the State or California to cause birth defects or other reproductive harm. For more information, go to [www.P65Warnings.ca.gov](http://www.P65Warnings.ca.gov).











# Temperature Monitoring

## Interface Cables

### Interface Cables

- Allows DeRoyal® temperature probes and sensors to connect to most monitors
- Length: 12 ft (3.6 m)
- Packaged 1/box
- Reusable
- Not made with natural rubber latex
- Non-sterile



Connection Profile	Connection End	Description
<b>81-101400</b>		
		Monitors requiring YSI 400 Series
<b>81-101700</b>		
		Monitors requiring YSI 700 Series
<b>81-1010HP</b>		
		Hewlett Packard® and Philips Monitors YSI 400 Series
<b>81-1010SM</b>		
		Siemens® Monitors YSI 400 Series
<b>81-1010MR</b>		
		Mindray® Monitors YSI 400 Series

### Esophageal Stethoscope Probes

- For use in surgical setting to monitor heart and respiratory sounds and to measure core body temperature in anesthetized patients
- Provides heart and respiratory sound transmission
- Complete line includes all popular French sizes
- Available in extra-long (22") length
- Available in regular and soft flexibility
- Thin distal cuff allows sound transmission and fidelity
- Not made with natural rubber latex
- Sterile

#### 400 Series/Regular Tube

Product #	Size	Qty
81-040409	9 FR	50/Cs
81-040412	12 FR	50/Cs
81-040418	18 FR	50/Cs
81-040424	24 FR	50/Cs

#### 400 Series/Soft Tube

Product #	Size	Qty
81-050409	9 FR	50/Cs
81-050412	12 FR	50/Cs
81-050418	18 FR	50/Cs
81-050424	24 FR	50/Cs

#### 400 Series/Extra-Long Length

Product #	Size	Qty
81-044418	18 FR	50/Cs

#### 700 Series/Regular Tube

Product #	Size	Qty
81-040709	9 FR	50/Cs
81-040712	12 FR	50/Cs
81-040718	18 FR	50/Cs

#### 700 Series/Soft Tube

Product #	Size	Qty
81-050718	18 FR	50/Cs

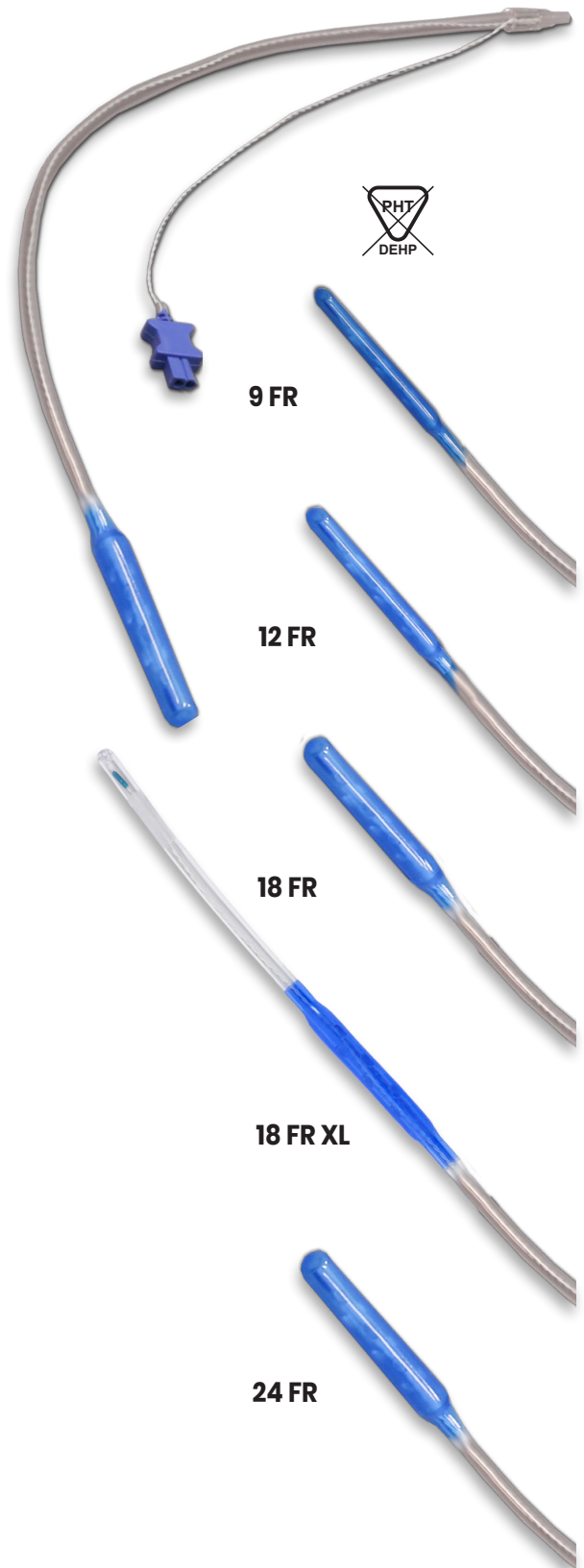

# Temperature Monitoring

## Core Temperature

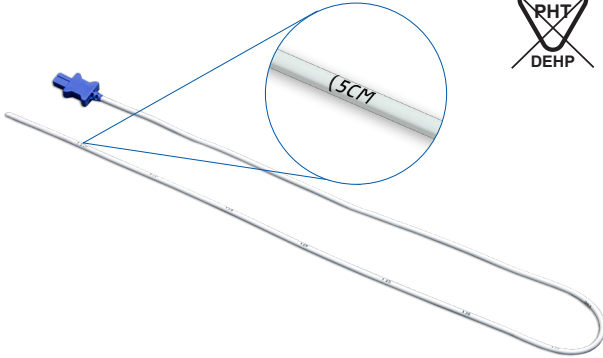

## General-Purpose Probes

- For routine monitoring of patient's core body temperature
- Versatile design allows for oral, nasal, or rectal introduction
- Low-friction surface improves ease of insertion
- Depth markings in 5 cm increments to indicate insertion depth
- Completely enclosed wire to prevent ingress of fluid or moisture
- Thin, flexible design
- Available in regular and soft flexibility
- Length: 2.3 ft (70 cm)
- Not made with natural rubber latex
- Sterile

### 400 Series Regular

Product #	Size	Qty
81-020409	9 FR	50/Cs
81-020412	12 FR	50/Cs

### 400 Series Soft

Product #	Size	Qty
81-02S409	9 FR	50/Cs
81-02S412	12 FR	50/Cs

### 700 Series Regular

Product #	Size	Qty
81-020709	9 FR	50/Cs



81-025400

## Nasopharyngeal Probes

- For routine monitoring of patient's core body temperature
- Optimized design for nasal insertion
- Soft sheath to minimize risk of epistaxis
- Low-friction surface improves ease of insertion
- Thin, flexible design
- Multiple sheath lengths available
- Not made with natural rubber latex
- Sterile

400 Series Product #	Sheath Length	Size	Qty
81-025400	3"	9 FR	50/Cs
81-025409	18"	9 FR	50/Cs

### Foley Catheters with Temperature Sensors

- For urinary drainage and simultaneous monitoring of core body temperature
- Dual-purpose design can be used before, during, or after surgery
- Color-coded hubs for size identification
- Complete range of sizes: 8 - 18 French
- Available single sterile or can be delivered in a Custom Procedural Tray
- Dependable 100% silicone tubing
- Certified as MR Conditional for use in Magnetic Resonance (MR) Environment at 1.5 and 3.0 Tesla
- Not made with natural rubber latex
- Sterile

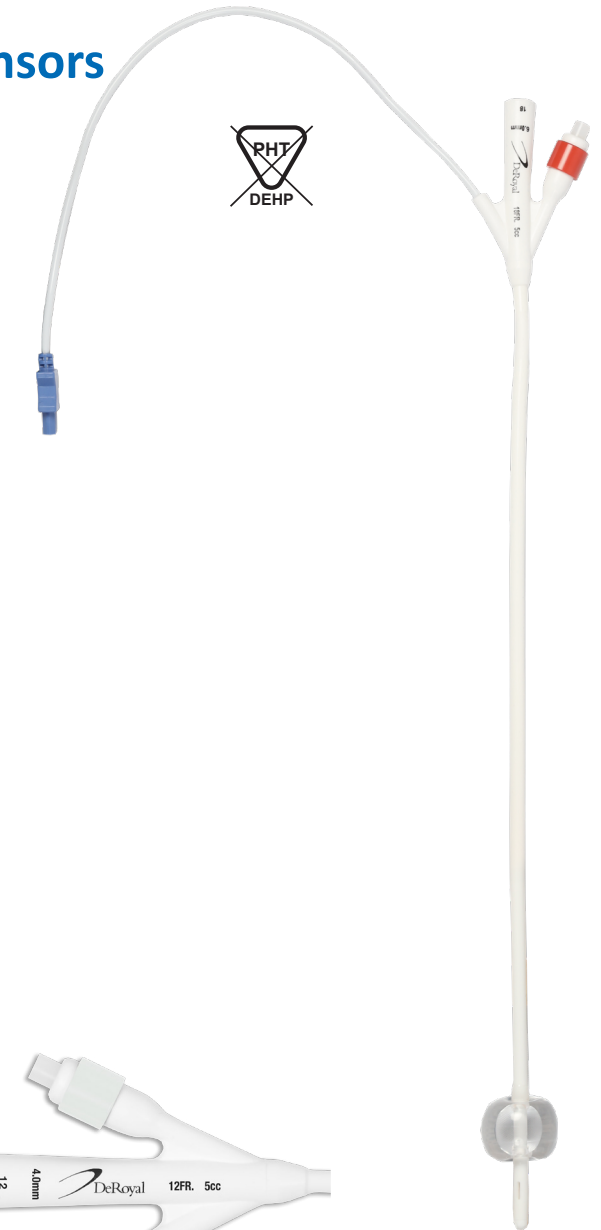

#### 400 Series

Product #	Size	Color	Qty
81-080408	8 FR	Brown	50/Cs
81-080410	10 FR	Black	50/Cs
81-080412	12 FR	White	50/Cs
81-080414	14 FR	Green	50/Cs
81-080416	16 FR	Orange	50/Cs
81-080418	18 FR	Red	50/Cs

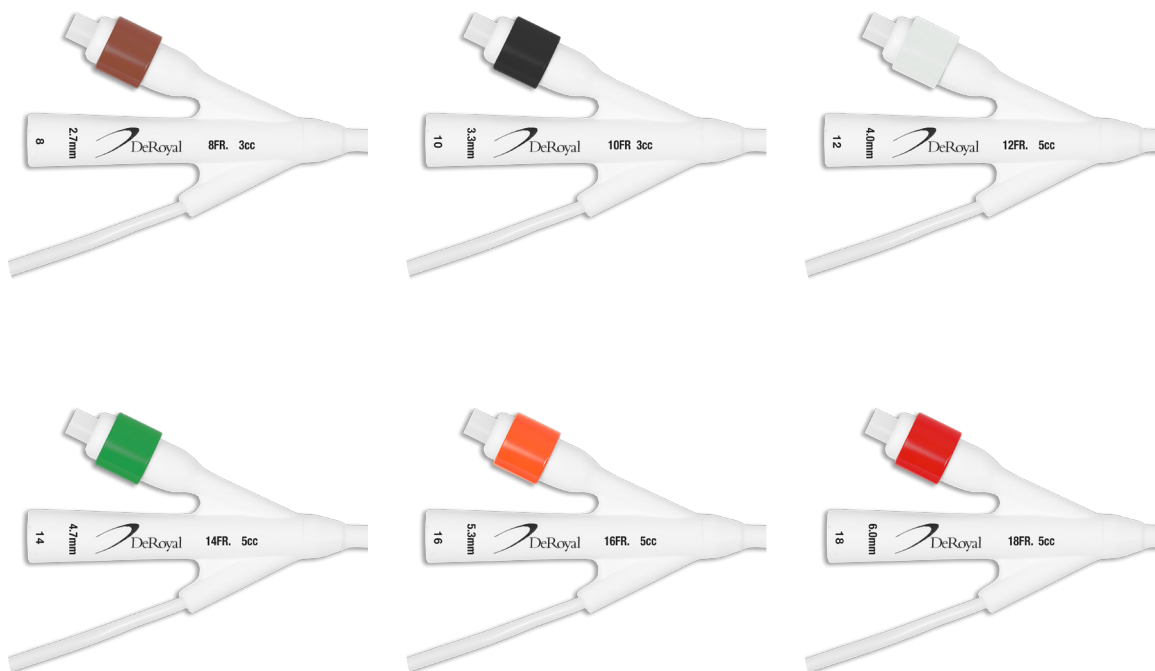

# Temperature Monitoring

## Core Temperature



### Foley Catheter Kits

- All items needed for the insertion of Foley Catheters, urine drainage, and measurement
- Kits contain: Foley Catheter (if applicable), urine meter with splash guard, lubricant jelly, prefilled syringe with sterile water, povidone iodine solution, specimen cup with lid, forceps, drape towels, nitrile gloves, cotton balls, and Royal wrap
- Available without catheter (81-080500)
- Not made with natural rubber latex
- Sterile

Product #	Catheter Size	Qty
81-080514	14 FR	10/Cs
81-080516	16 FR	10/Cs
81-080518	18 FR	10/Cs
81-080500	n/a	10/Cs

### Multi-Purpose Tube Holder

- Ideal for securing Foley Catheters and a variety of tubes and catheters
- Adhesive loop securely holds Foley Catheter in place and helps prevent tube dislodgment
- Designed for quick and easy placement of all sizes of tubing and lines
- Easy-to-apply adhesive base attaches firmly to skin, cloth, or drapes
- Gentle to skin and easily removed without painful pulling
- Holds lines securely in place, once line is positioned on patient
- Secure placement for positioning to create slack without bladder traction, thus decreasing risk of urinary tract infection
- Easy to position and reposition tabs
- Made with natural rubber latex
- Non-sterile

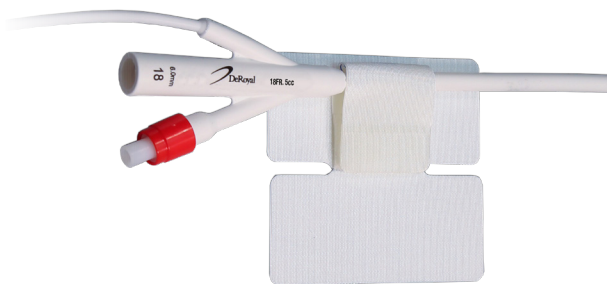

#### For use with:

- Jejunostomy tubing
- Leg Bag tubing
- Subclavian port lines
- Wound drainage tubing
- Peritoneal dialysis exit site tubing
- A variety of other tubes and catheters

Product #	Size	Qty
30-1002*	Medium	50/Cs
30-1003*	Large	50/Cs

**!** \*WARNING- This product can expose you to chemicals including Ethylbenzene, which is known to the State or California to cause cancer, and Toluene, which is known to the State of California to cause birth defects or other reproductive harm. For more information, go to [www.P65Warnings.ca.gov](http://www.P65Warnings.ca.gov).



# Temperature Monitoring

## Core Temperature

### Tympanic Probes

- Designed for atraumatic measurement of patient's core body temperature from the aural canal
- Contoured ear piece
- Soft cotton tip
- Wire length 3 ft (90 cm) allows for patient movement
- Available without foam ear plug (81-090401)
- Not made with natural rubber latex
- Non-sterile

#### 400 Series

Product #	Qty
81-090400	50/Cs
81-090401	50/Cs



81-090400



### Myocardial Probes

- Used to monitor the temperature of the myocardium during open heart surgeries
- Available in a full range of popular sizes
- Small diameter (21 GA) stainless steel needle for less traumatic applications
- Needle hub with suture holes improves probe accuracy and minimizes operating site interference
- Length: 5 ft (1.5 m)
- Not made with natural rubber latex
- Sterile

#### 400 Series

Product #	Needle Length	Qty
81-030408	8 mm	20/Cs
81-030415	15 mm	20/Cs
81-030418	18 mm	20/Cs
81-030430	30 mm	20/Cs

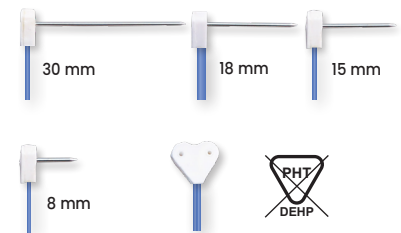

# Temperature Monitoring

## Skin Surface Temperature



### Adult Skin Sensors

- Highly accurate skin sensor provides reliable surface temperature readings
- Can be used in all clinical settings requiring routine monitoring of the patient's surface temperature
- Non-irritating adhesive is less traumatic to patient's skin
- Length: 2.3 ft (70 cm)
- Not made with natural rubber latex
- Sterile

#### 400 Series

**Product #**  
81-010400

**Qty**  
50/Cs

#### 700 Series

**Product #**  
81-010700

**Qty**  
50/Cs

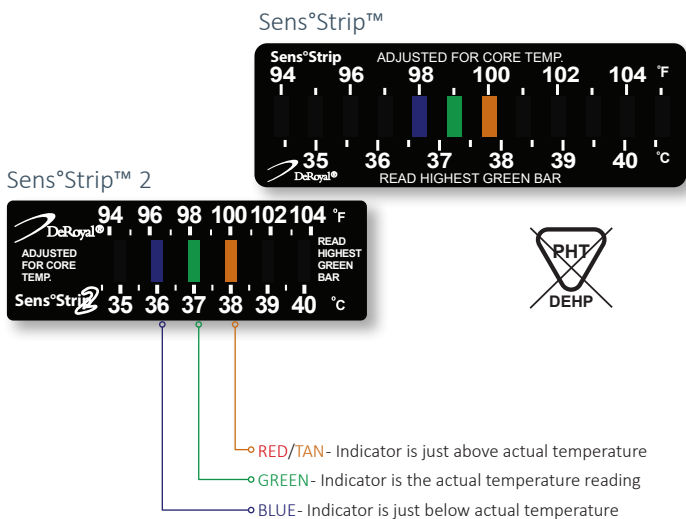

### LCD Sens°strip™ Temperature Trend Indicators

- Temperature continuously displayed in 1° increments while adjusting for core temperature
- Provides a baseline temperature that can be monitored to determine if the temperature is rising or staying constant
- Changes in color from RED/TAN to GREEN to BLUE that correlates to a change in temperature
- Provides a convenient, accurate, and inexpensive way to monitor a patient's temperature trends
- May be used in conjunction with temperature probes
- Not made with natural rubber latex
- Non-sterile

Product #	Description	Packaging	# Bars/Increments	Size	Qty
81-010000	LCD Sens°strip™ Trend Indicator	Envelope	12 bars/1° F increments	.75" x 2.5"	100/Cs
81-010001	LCD Sens°strip™ Trend Indicator	Dispenser Box	12 bars/1° F increments	.75" x 2.5"	100/Cs
81-010003	LCD Sens°strip™ 2 Trend Indicator	Dispenser Box	6 bars/1° C increments	.625" x 1.75"	100/Cs
81-0100BX	Acrylic Holder, Non-sterile				10/Cs

## DeRoyal® Neonatal Skin Temperature Sensors

Provides comfortable and precise management of neonatal patient's vital signs. Our neonatal temperature monitoring sensors are available in a number of designs and interfaces, making it easier for practitioners to customize their product needs to their patient needs. Through this large product offering, DeRoyal is able to provide a wide array of cost-effective treatment options, designed with fragile neonatal patients in mind.

- Provides reliable skin temperature reading
- Compatible with the most common neonatal temperature monitoring and warming equipment
- Unique color-coding system ensures proper sensor identification during use and storage
- Packaged with a reflective sensor cover that deflects radiant heat for more accurate readings
- Disposable replacement covers available (see pg 12) in choice of hydrogel or adhesive pads to adhere to fragile infant skin without irritation
- For more information on corresponding machines, please contact DeRoyal Customer Service

## The DeRoyal® Neonatal Skin Sensors are available in 2 options:

**OPTION**  
**1**  
Fully Disposable



HNICU-37

### One-Piece Disposable Sensor

**OPTION**  
**2**  
2-Piece System

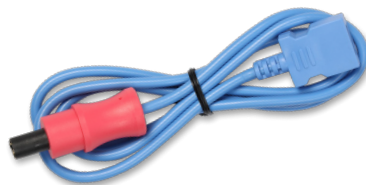

NI-37

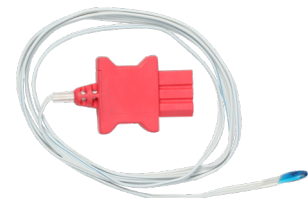

FNICU-37

### Reusable Interface Cable

### Disposable Sensor

# Temperature Monitoring

## Neonatal

OPTION

1

Fully Disposable



## Neonatal One-Piece Sensors

- Length: 5 ft (1.5 m)
- Packaged 50 sensors/case
- Packaged with variety of sensor covers
- Not made with natural rubber latex
- Non-sterile



Connection Profile	Connection End	Sensor Cover	Connection Profile	Connection End	Sensor Cover
<b>HNICU-22</b>		 7/8"	<b>HNICU-36</b>		 7/8"
<b>HNICU-25</b>		 7/8"	<b>HNICU-37</b>		 7/8"
<b>HNICU-26</b>		 7/8"	<b>HNICU-38</b>		 7/8"
<b>HNICU-32</b>		 7/8"	<b>HNICU-39</b>		 1 1/8"
<b>HNICU-35</b>		 1 1/8"			

OPTION

**2**

2-Piece System

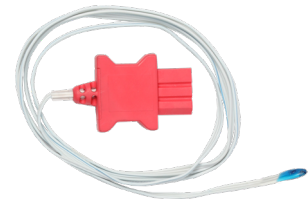
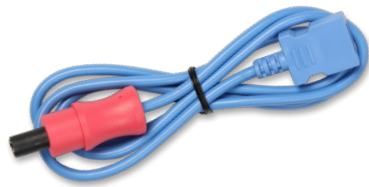

Reusable Interface Cable

Disposable Sensor

## Neonatal Two-Piece Sensor System

DeRoyal's reusable temperature system allows replacement of the disposable skin temperature sensor only

### Reusable Interface Cable

- Length: 3 ft (0.91 m)
- Packaged 1/box
- Reusable
- Not made with natural rubber latex
- Non-sterile



### Disposable Skin Sensor

- Length: 2.5 ft (0.76 m)
- Packaged with 7/8" hydrogel skin sensor cover
- Packaged 50 sensors/case
- Not made with natural rubber latex
- Non-sterile

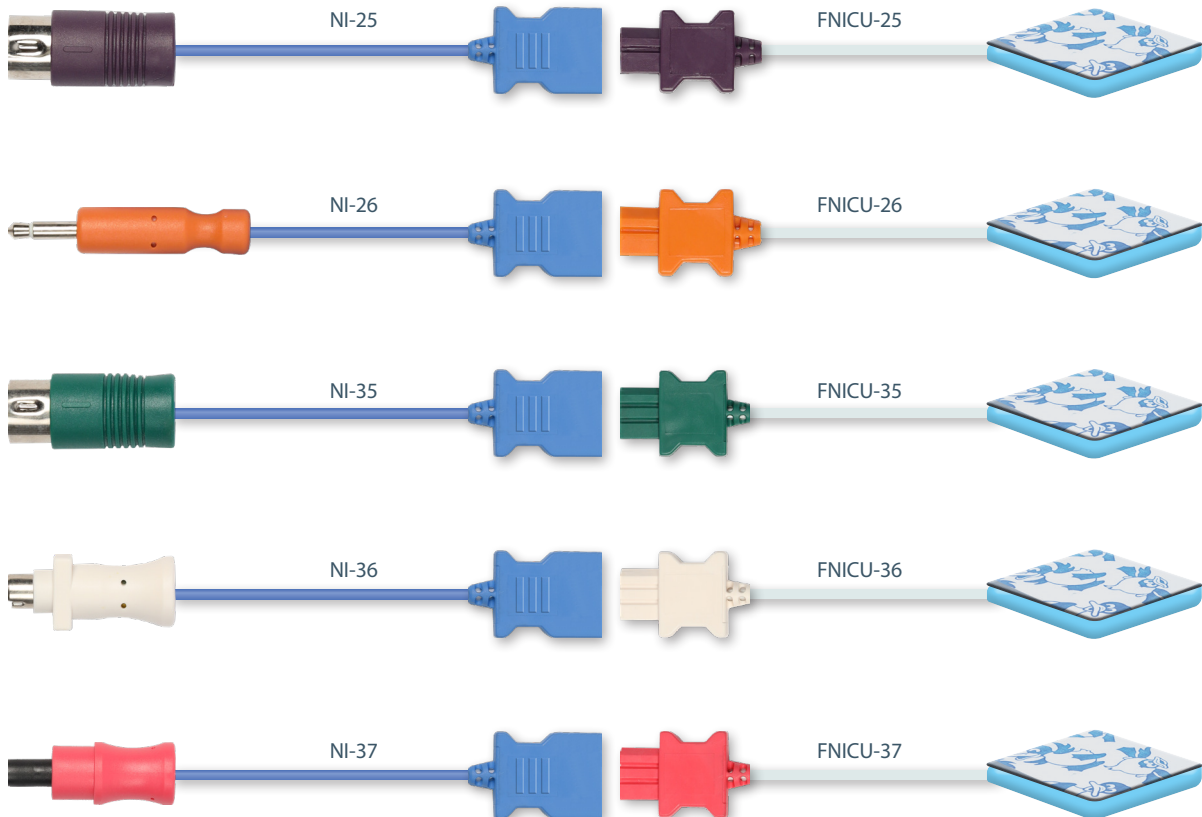



# Temperature Monitoring

Neonatal

## Neonatal Sensor Replacement Cover System

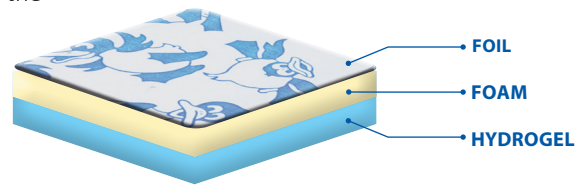
- Cover insulates the sensor from ambient room temperature
- Reflective sensor cover deflects radiant heat for more accurate readings
- Two sizes available
- Hydrogel and acrylic adhesive options
- Hydrogel covers available with or without foam to maximize conformability
- Hydrogel adhesive reduces risk of epidermal stripping and allows the removal or relocation of sensors without disrupting skin integrity
- Packaged 200/case
- Not made with natural rubber latex
- Non-sterile

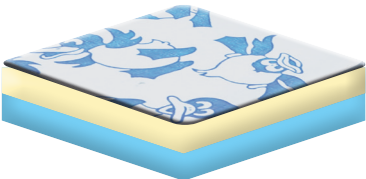

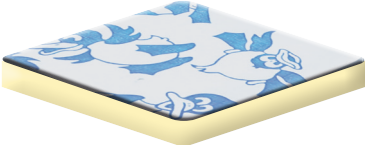
Type	Foam w/ Hydrogel		Hydrogel		Foam w/ Acrylic	
Layers						
Size	7/8" (2 cm)	1 1/8" (3 cm)	7/8" (2 cm)	1 1/8" (3 cm)	7/8" (2 cm)	1 1/8" (3 cm)
Part #	HNICU-00	HNICU-01	HNICU-02	HNICU-03	HNICU-04	HNICU-05

### SafeLiner® Semi-Rigid Liner System

- Hydrophobic filter technology helps prevent backflow of aspirated fluids into hospital vacuum systems
- Innovative adhesive seal keeps lid securely in place to help prevent leakage and spills
- Self-aligning lid allows for quick and easy assembly
- Larger ports for better suction
- Filter traps aerosolized microorganisms
- Liners are nested for efficient packaging and storage
- Single-patient use
- Outer shell with bracket is reuseable
- Not made with natural rubber latex
- Non-sterile



Semi-Rigid Outer Shell w/ Bracket

### SafeLiner® Semi-Rigid Liner System

Product #	Description	Qty
PHESL-1000B	1000 cc Liner w/ elbow	100/Cs
PHESL-1500B	1500 cc Liner w/ elbow	100/Cs
PHESL-3000B	3000 cc Liner w/ elbow	50/Cs

### SaferLiner® Semi-Rigid Outer Shell with Hardware

Product #	Description	Qty
71-1000BR	1000 cc Outer Shell w/ bracket	1/Ea
71-1000BRB	1000 cc Outer Shell w/ bracket	20/Cs
71-1000DS±	1000 cc Outer Shell w/ DISS Assembly	1/Ea
71-1000DSB±	1000 cc Outer Shell w/ DISS Assembly	20/Cs
71-1500BR	1500 cc Outer Shell w/ bracket	1/Ea
71-1500BRB	1500 cc Outer Shell w/ bracket	20/Cs
71-1500DS±	1500 cc Outer Shell w/ DISS Assembly	1/Ea
71-1500DSB±	1500 cc Outer Shell w/ DISS Assembly	20/Cs
71-3000BR	3000 cc Outer Shell w/ bracket	1/Ea
71-3000BRB	3000 cc Outer Shell w/ bracket	12/Cs



Semi-Rigid Outer Shell w/ DISS Assembly

### SaferLiner® Semi-Rigid Liner with Tubing

Product #	Description	Qty
71-6516*	1000 cc Liner, Elbow and 3/16" x 6' tubing	72/Cs
71-6517*	1000 cc Liner, Elbow and 1/4" x 6' tubing	72/Cs
71-6526*	1500 cc Liner, Elbow and 3/16" x 6' tubing	72/Cs
71-6527*	1500 cc Liner, Elbow and 1/4" x 6' tubing	72/Cs
71-6529*	1500 cc Liner, Elbow and 1/4" x 10' tubing	72/Cs
71-6539*	3000 cc Liner, Elbow and 1/4" x 10' tubing	36/Cs



\*WARNING- This product can expose you to chemicals including Ethylbenzene, which is known to the State or California to cause cancer. For more information, go to [www.P65Warnings.ca.gov](http://www.P65Warnings.ca.gov).



\*WARNING- This product can expose you to chemicals including di(2-ethylhexyl)phthalate, which is known to the State of California to cause cancer and birth defects or other reproductive harm. For more information, go to [www.P65Warnings.ca.gov](http://www.P65Warnings.ca.gov).



# Waste Fluid Management

## Suction Canisters



### Crystaline® ECO Rigid Canister System

- Patented dome design provides increased implosion protection when exposed to lipids in bodily fluids
- Hydrophobic filter technology helps prevent backflow of aspirated fluids into hospital vacuum systems
- Tether management with tear-away membrane for ease of use
- Larger ports for better suction
- Completely disposable
- 800 cc, 1200 cc, 1500 cc, and 2500 cc capacities
- Secure press-on lids
- Filtration of staphylococcus aureus at 99.5% efficiency
- Filter traps aerosolized microorganisms
- Single-patient use
- Not made with natural rubber latex
- Non-sterile

#### Crystaline® ECO Rigid Canister System

Product #	Description	Qty
71-0800	800 cc Canister	50/Cs
71-0805	800 cc Canister w/ DISS Mount	50/Cs
71-8002	1200 cc Canister, 2 elbows	40/Cs
71-8005	1200 cc Canister w/ DISS Mount, 1 elbow	40/Cs
71-8003	1500 cc Canister, 2 elbows	40/Cs
71-8004	2500 cc Canister, 2 elbows	32/Cs

#### Crystaline® ECO Rigid Canister System with Tubing

Product #	Description	Qty
71-8009*	800 cc Canister, ¼" x 6' connector tubing	30/Cs
71-8010*	1200 cc Canister, 2 elbows, ¾" x 6' connector tubing	30/Cs
71-8011*	1200 cc Canister, 2 elbows, ¼" x 6' connector tubing	30/Cs
71-8012*	1200 cc Canister, 2 elbows, ¾" x 1.5' & ¾" x 6' connector tubing	30/Cs
71-8013*	1500 cc Canister, 2 elbows, ¼" x 6' connector tubing	30/Cs



### Critical Measurement Canisters

- Ideal where small volumes of fluid must be accurately measured
- 300 cc total capacity
- Fits in standard 1200 cc wall bracket
- Clear, easy-to-read graduations with calibrations in 5 cc increments
- ± 10% accuracy at 0 - 50 cc; ± 5% accuracy at 55 - 300 cc
- Steps at 50 cc and 150 cc for fast and easy "at-a-glance" readings
- Can be used as stand-alone or in tandem
- Includes shut-off filter mechanism
- Completely disposable
- Not made with natural rubber latex
- Non-sterile

Product #	Description	Qty
71-7101	300 cc Canister	48/Cs

**!** \*WARNING- This product can expose you to chemicals including di(2-ethylhexyl)phthalate, which is known to the State of California to cause cancer and birth defects or other reproductive harm. For more information, go to [www.P65Warnings.ca.gov](http://www.P65Warnings.ca.gov).



### Omni-Jugs® Suction Canisters

- 16 liter disposable rigid canisters, the largest on the market
- Allows use of up to four devices simultaneously
- Eliminates changing canisters during heavy fluid procedures
- Built-in handles allow for easier transport when full
- Fits OR roll stand for easier transport
- Floor dolly available for easy movement during and after procedure
- Completely disposable
- Not made with natural rubber latex
- Non-sterile



Product #	Description	Qty
5036-00	16 Liter Canister	4/Cs
5036-01	16 Liter Canister w/ Collection Sock	4/Cs
5036-05	16 Liter Canister Roll Stand	1/Ea
5036-10	Floor Dolly	1/Ea

### Drain-Jug™ Container

- Eliminates the need for floor drains
- Collects fluid waste from any drape, pouch, or pump utilizing gravity
- Great for arthroscopic drain pumps and cystoscopic pouches
- Replaces use of hazardous, open-topped kick buckets
- Fits floor dolly for easy transport
- Not made with natural rubber latex
- Non-sterile



Product #	Description	Qty
6036-00	15 Liter Container	10/Cs
5036-10	Floor Dolly	1/Ea

# Waste Fluid Management

## Suction Tubing

### Suction Tubing with Connectors

- Molded female connectors provide secure connection
- Male connector included for coupling additional tubes
- Minimal coil memory allows for easy handling and drapability
- Color coded connectors for size identification
- Available in economical non-sterile 100 ft rolls with intergraded connectors
- 100 ft rolls include 16 rigid male connectors
- Not made with natural rubber latex
- Sterile



#### **3/16" Tubing with Green Female Connectors**

Product #	Description	Qty
71-C501*	3/16" x 1.5' (5 mm x .46 m)	100/Cs
71-C506*	3/16" x 6' (5 mm x 1.8 m)	50/Cs
71-C510*	3/16" x 10' (5 mm x 3.0 m)	30/Cs
71-C512*	3/16" x 12' (5 mm x 3.7 m)	30/Cs
71-C520*	3/16" x 20' (5 mm x 6.1 m)	25/Cs
71-C5100NS*	3/16" x 100' (5 mm x 30 m)	1RL/Bx



#### **1/4" Tubing with Light Blue Female Connectors**

Product #	Description	Qty
71-C606*	1/4" x 6' (6 mm x 1.8 m)	45/Cs
71-C610*	1/4" x 10't (6 mm x 3.0 m)	25/Cs
71-C612*	1/4" x 12' (6 mm x 3.7 m)	25/Cs
71-C620*	1/4" x 20' (6 mm x 6.1 m)	20/Cs
71-C6100NS*	1/4" x 100' (6 mm x 30 m)	1RL/Bx



#### **3/32" Tubing with Dark Blue Female Connectors**

Product #	Description	Qty
71-C706*	3/32" x 6' (7 mm x 1.8 m)	40/Cs
71-C710*	3/32" x 10' (7 mm x 3.0 m)	20/Cs
71-C712*	3/32" x 12' (7 mm x 3.7 m)	20/Cs
71-C720*	3/32" x 20' (7 mm x 6.1 m)	15/Cs
71-C7100NS*	3/32" x 100' (7 mm x 30 m)	1RL/Bx



 \*WARNING- This product can expose you to chemicals including di(2-ethylhexyl)phthalate, which is known to the State of California to cause cancer and birth defects or other reproductive harm. For more information, go to [www.P65Warnings.ca.gov](http://www.P65Warnings.ca.gov).

### Flexible Suction Handles

- Constructed of a malleable non-breakable vinyl with smooth inner lumen
- Highly flexible for precise suctioning
- Transparent for visual monitoring and inspection during use
- Available in three tip styles for different volumes of suction (fine, regular, or high)
- Side eyes help to reduce the chance of tissue grab and/or trauma
- Vented option available with regular capacity
- Not made from natural rubber latex
- Sterile

Product #	Description	Qty
71-D860	Fine capacity	50/Cs
71-D861	Regular capacity	50/Cs
71-D861V	Regular capacity, vented	50/Cs
71-D862	High capacity	50/Cs



71-D861

### Poole Suction Handle

- Constructed of a shatter-resistant plastic
- Designed to remove pooled blood and fluids during surgical procedures
- Features three multipurpose positions that convert from sump action to pinpoint capabilities
- Outer sheath has 132 large eyes for rapid suctioning while reducing tissue grab
- Inner cannula provides pinpoint suctioning
- Universal connector for easy connection to a variety of tubing sizes
- Not made from natural rubber latex
- Sterile

Product #	Description	Qty
71-D8770	Poole Suction Handle	50/Cs



71-D8770

### Frazier Suction Handles

- Ideal for surgical procedures that require fine and delicate suctioning
- Malleable shaft can be bent to desired position without occlusion
- Obturator can be used to facilitate shaping of shaft and/or removal of obstructions that may become trapped during suctioning
- Obturator must be removed before suctioning begins
- Control vent allows for intermittent or continuous suction control
- Universal connector for easy connection to a variety of tubing sizes
- Not made from natural rubber latex
- Sterile

Product #	Description	Qty
71-D871	8 French	50/Cs
71-D872	10 French	50/Cs
71-D873	12 French	50/Cs

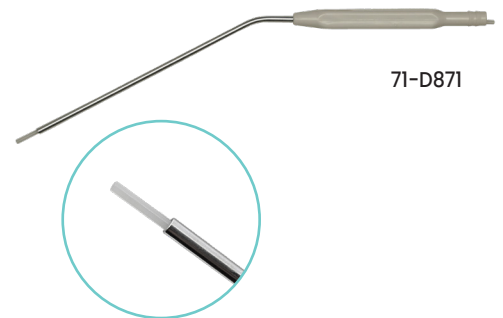

71-D871

# Waste Fluid Management

## Suction Handles

### Yankauer Suction Handles

- Constructed of a shatter-resistant plastic
- Smooth inner surface for maximum flow
- Slip-resistant and lightweight, provides optimal control and maneuverability
- Translucent material allows for visual monitoring and inspection during use
- Available in three tip styles: bulbous, tapered bulbous, and straight
- Bulbous tip is rounded to help minimize tissue grab and/or trauma
- Tapered bulbous tip helps minimize tissue grab and/or trauma, while allowing for better visibility
- Straight tip provides less bulk, allowing for better visibility
- Each tip has side eyes to help reduce tissue grab
- Available with control vent for intermittent or continuous suction control
- Available with pre-attached tubing
- Not made from natural rubber latex
- Sterile

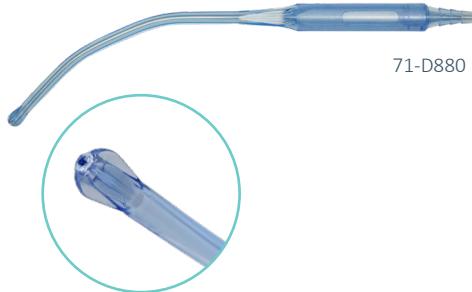

71-D880

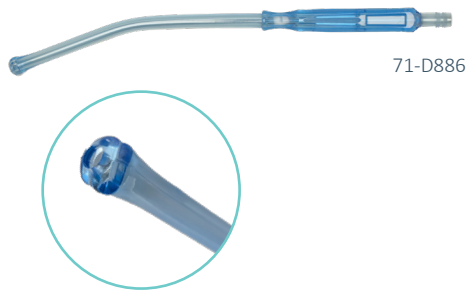

71-D886

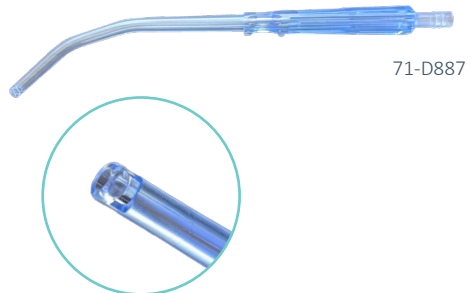

71-D887



71-D888

Product #	Description	Qty
71-D886	Bulbous tip, non-vented	50/Cs
71-D886V	Bulbous tip, vented	50/Cs
71-D880	Tapered bulbous tip, non-vented	50/Cs
71-D882	Tapered bulbous tip, vented	50/Cs
71-D887	Straight tip, non-vented	50/Cs
71-D887V	Straight tip, vented	50/Cs
71-D888	Bulbous Tip with On/Off Switch	50/Cs
71-D883A*	Tapered bulbous tip, non-vented with 1/4" (6 mm) x 6' (1.8 m) tubing	50/Cs
71-D884*	Tapered bulbous tip, non-vented with 1/4" (6 mm) x 9' (2.7 m) tubing	25/Cs
71-D885*	Tapered bulbous tip, non-vented with 1/4" (6 mm) x 12' (3.7 m) tubing	25/Cs



71-D883A

 \*WARNING- This product can expose you to chemicals including di(2-ethylhexyl)phthalate, which is known to the State of California to cause cancer and birth defects or other reproductive harm. For more information, go to [www.P65Warnings.ca.gov](http://www.P65Warnings.ca.gov).

### 5-in-1 Straight Connector

- Compatible with a variety of medical tubing
- Fits tubing sizes  $\frac{3}{16}$ " to  $\frac{7}{16}$ " (5 to 11 mm)
- Available in sterile and non-sterile

Product #	Description	Qty
71-515S	Sterile	1/Pch, 25 Pch/Bx, 8 Bx/Cs, 200/Ea
71-515N	Non-sterile	50/Bg, 1 Bg/Bx, 10 Bx/Cs, 500/Ea



### 6-in-1 Y Connector

- Compatible with a variety of medical tubing
- Fits tubing sizes  $\frac{1}{4}$ " to  $\frac{5}{8}$ " (6 to 15 mm)
- Available in sterile and non-sterile

Product #	Description	Qty
71-616S	Sterile	1/Pch, 15 Pch/Bx, 8 Bx/Cs, 120/Ea
71-616N	Non-sterile	15/Bg, 1 Bg/Bx, 10 Bx/Cs, 150/Ea

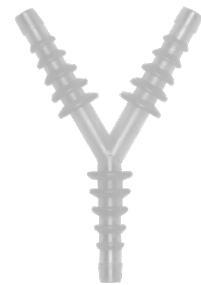

### Sims Connector

- Compatible with a variety of medical tubing
- Fits tubing sizes  $\frac{1}{8}$ " to  $\frac{1}{4}$ " (3 to 6 mm)
- Available in sterile and non-sterile

Product #	Description	Qty
71-618S	Sterile	1/Pch, 50 Pch/Bx, 8 Bx/Cs, 400/Ea
71-618N	Non-sterile	50/Bg, 1 Bg/Bx, 10 Bx/Cs, 500/Ea



### T Connector

- Compatible with a variety of medical tubing
- Fits tubing sizes  $\frac{3}{16}$ " to  $\frac{7}{16}$ " (5 to 11 mm)
- Available in sterile and non-sterile

Product #	Description	Qty
71-619S	Sterile	1/Pch, 15 Pch/Bx, 8 Bx/Cs, 120/Ea
71-619N	Non-sterile	15/Bg, 1 Bg/Bx, 10 Bx/Cs, 150/Ea



### Elbow Right Angle Connector

- Connect suction tubing to ports at a 90° angle

Product #	Description	Qty
71-1118	Non-sterile	100/Cs



# Waste Fluid Management

## Solidifier



## Solidifier

- Solidifies potentially serious infectious waste within the suction canister quickly and effectively
- Quickly penetrates throughout canister to solidify blood and bodily fluids
- No shaking required
- Retains solidity to prevent spills and leaks for safe and easy red bag disposal
- Concentrated formula: one ounce cost-effectively solidifies 1000 cc of liquid
- Chlorine-free for non-toxic incineration
- Not made with natural rubber latex
- Non-sterile

Product #	Package Type	Volume Solidified	Qty
71-0500	Dissolvable Pouch	500 cc	200/Cs
71-1000	Dissolvable Pouch	1000 cc	96/Cs
71-1200	Bottle w/ Yorker Cap	1200 cc	96/Cs
71-1500	Bottle w/ Yorker Cap	1500 cc	96/Cs
71-2005	Bottle w/ Yorker Cap	2000 cc	36/Cs
71-3000	Bottle w/ Yorker Cap	3000 cc	36/Cs
71-9000	Bottle w/ Yorker Cap	9000 cc	12/Cs
71-18000	Bottle w/ Yorker Cap	18000 cc	12/Cs

## Premium Solidifier



- Quickly encapsulates liquid medical waste
- Helps reduce OR turnover time
- U.S. Environmental Protection Agency (EPA) registered liquid medical waste treatment
- Solidified medical waste is rendered non-infectious
- White bag disposal in EPA-approved states\*
- Not made with natural rubber latex
- Non-sterile

Product #	Package Type	Volume Solidified	Qty
71-1000S	Bottle w/ Twist Cap	1000 cc	100/Cs
71-1500S	Bottle w/ Twist Cap	1500 cc	100/Cs
71-3000S	Bottle w/ Twist Cap	3000 cc	100/Cs

\*Contact DeRoyal Customer Service for details

## Puddle Guppy® Floor Aspirator

- Disposable floor aspirator to quickly remove fluid from OR floor
- The only floor aspirator with a detachable “Fish Stick™” push handle
- Great for clean up during and after high fluid cases
- Includes 72” suction tubing
- Not made with natural rubber latex
- Non-sterile



Product #	Description	Qty
5036-30*	Puddle Guppy® Floor Aspirator (Includes 1 Fish Stick™ handle)	30/Cs
5036-31*	Puddle Guppy® Floor Aspirator w/ Clamp (Includes 1 Fish Stick™ handle)	30/Cs
5036-35	Fish Stick™ push handle	10/Cs

## H2NO® Suction & Anti-Fatigue Mat

- Lightweight for ease of set-up and disposal resulting in improved room turnover times
- Economical for heavy fluid procedures helping to eliminate laundry on the floor
- Provides strong, quiet suction with anti-fatigue properties
- Non-skid design with fluid channels to reduce standing fluid
- Single use eliminates cross contamination possibilities
- Not made with natural rubber latex
- Non-sterile



Product #	Description	Size	Qty
H2NO	H2NO® Suction and Anti-Fatigue Mat	56” x 40”	10/Cs

 \*WARNING- This product can expose you to chemicals including di(2-ethylhexyl)phthalate, which is known to the State of California to cause cancer and birth defects or other reproductive harm. For more information, go to [www.P65Warnings.ca.gov](http://www.P65Warnings.ca.gov).



# Waste Fluid Management

## Specialty Fluid Control

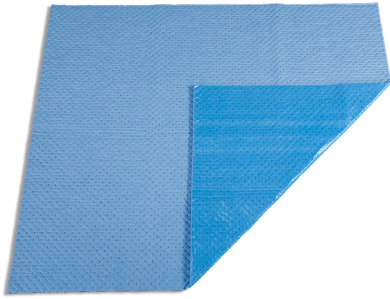

### Blue Absorbent Mats

- Three sizes to accommodate any size operating room, lab station, decontamination room, or scrub sink
- Accommodates rolling casters on carts and accessories helping to prevent tearing or bunching
- Laminated impermeable backing eliminates fluid contact with floor to help prevent staining
- Reduces linen use
- Not made with natural rubber latex
- Non-sterile

Product #	Description	Size	Qty
71-4304	Small	46" x 40"	10/Cs
71-4305	Medium	46" x 72"	10/Cs
71-4306	Large	46" x 125"	10/Cs



### Grey Absorbent Mats

- Helps prevent fluids from hitting the floor to address slip and fall incidents
- Large sizes allow three people on mat at once
- May be positioned in a variety of locations for use in different procedures
- Accommodates rolling casters on carts
- Stationary, non-skid surface
- Lightweight for easy clean up and removal
- Reduces linen use
- Unique absorbent surface helps prevent fluid splashes
- Not made with natural rubber latex
- Non-sterile

Product #	Description	Size	Qty
71-4301	Floor Mat	48" x 30"	32/Cs
71-4301L	Floor Mat w/ Poly Backing	48" x 30"	10/Cs
71-4302	Floor Mat	48" x 60"	16/Cs
71-4302L	Floor Mat w/ Poly Backing	48" x 60"	10/Cs



## Pink Absorbent Mats

- Made of super absorbent polymers and layered absorbent fibers for heavy fluid control
- Contains up to 60% recycled content with pliable fibers for folding and easy storage
- Helps prevent fluids from ever hitting the floor to address slip and fall incidents
- Laminated impermeable backing eliminates fluid contact with floor to help prevent staining
- Accommodates rolling casters on carts
- Stationary, non-skid surface
- Lightweight for easy clean up and removal
- Reduces linen use
- Not made with natural rubber latex
- Non-sterile



Product #	Description	Size	Qty
71-4312	Medium	30" x 56"	10/Cs
71-4313	Large	48" x 56"	10/Cs

## The Surgical Mat™ & The Mini Mat® Disposable Surgical Mats

- Patented, antimicrobial disposable surgical mat
- Address three major OR issues: surgical comfort, fluid buildup, and OR safety
- Non-slip molded foam with custom tapered fluid channels
- Fluid channels aid in keeping surgical team's feet dry and help reduce the risk of tracking body fluids throughout the OR suite
- Elasticity and cushioning provide exceptional comfort during prolonged procedures, mitigating foot, leg, and back pain
- Not made with natural rubber latex
- Non-sterile

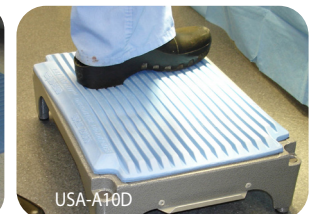
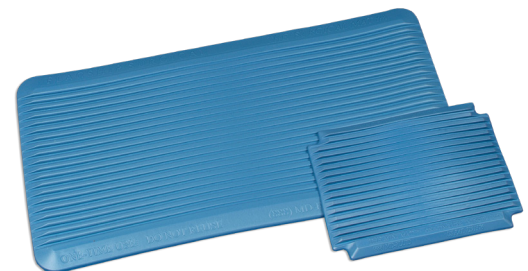

Product #	Description	Size	Qty
USA-010D	The Surgical Mat™	20" x 39"	10/Cs
USA-A10D	The Mini Mat®	13" x 17"	10/Cs

# Waste Fluid Management

## Specialty Fluid Control



### The Smooth Mat™ Disposable Surgical Mat

- Ergonomic surgical mat designed for use in the OR specifically for longer, dry surgical procedures
- Reduces the exhaustive pain and discomfort from standing for extended periods of time in the OR
- Not made with natural rubber latex
- Non-sterile

Product #	Description	Size	Qty
USA-S10D	The Smooth Mat™	20" x 39"	10/Cs

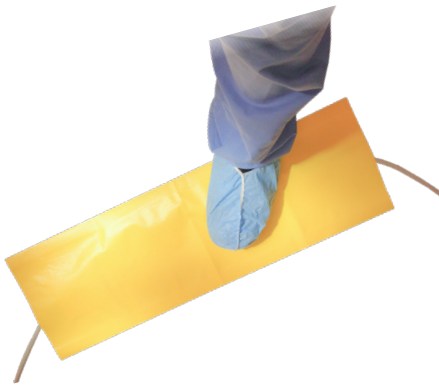

### Safe Cord™ Floor Strip

- Durable, disposable safety strip designed to cover cables and cords on the OR floors helping to reduce the risk of staff tripping hazards and injuries
- Adhesive strips on the underside secure the product to the floor without leaving any residue
- Easy to see bright yellow for added staff safety
- Can be safely walked on or rolled over by equipment without compromising function
- Simple set-up, removal, and disposal
- Not made with natural rubber latex
- Non-sterile

Product #	Description	Size	Qty
71-4311	Safe Cord™ Floor Strip	9" x 28"	30/Cs

### Suction Accessories

- Compatible with all DeRoyal® canisters, suction, and fluid control products
- Equips staff for even the most complex set-up

Product #	Description	Qty
71-1123	7" Collection Sock, General	20/Cs
71-1122	10" Collection Sock, Orthopedic	20/Cs
71-2066	10" Collection Sock, w/ weights	20/Cs
71-1124	Connector, Five-in-One	50/Cs
71-1165	Connector, T-style, 3/16" to 7/16"	10/Cs
71-1118	Elbow (Right Angle Connector)	100/Cs
71-2083*	Tubing, 3/16" x 18" Connector	100/Cs
71-1142	Tubing, 3/16" x 18" Funnel	100/Cs
71-2082	Tubing, 3/16" x 6' Funnel	50/Cs
71-2063	Tubing, 3/16" x 36" Funnel	50/Cs
71-2084*	Tubing, 1/4" x 6' Connector	50/Cs
71-2086*	Tubing, 1/4" x 12' Connector	50/Cs
71-2085*	Tubing, 1/4" x 20' Connector	20/Cs
71-8100RNS	Tubing, Reinforced, Clear 5/16" x 100'	1/Roll



Collection Sock (71-1123)



Five-in-One Connector (71-1124)



Elbow (71-1118)

 \*WARNING- This product can expose you to chemicals including di(2-ethylhexyl)phthalate, which is known to the State of California to cause cancer and birth defects or other reproductive harm. For more information, go to [www.P65Warnings.ca.gov](http://www.P65Warnings.ca.gov).

# Waste Fluid Management

## Suction Hardware & Accessories

Suction Hardware Guide		
Part #	Description	Use/Notes
71-1119*	Plastic DISS Adapter	Universal plastic regulator adapter (polycarbonate); both female and male fittings. DISS (Diameter-Indexed Safety System)
71-5014	Bracket, Flat Ring, 1200 cc	Metal three-hole flat bracket for 1200 cc rigid canisters. Typically used when hung from a wall regulator with polycarbonate DISS adapter (71-1119*)
71-2098	Bracket, Flat Ring, 1500/2500 cc	Metal three-hole flat bracket for 1500/2500 cc rigid canisters. Typically used when hung from a wall regulator with polycarbonate DISS adapter (71-1119*)
71-5003	Bracket, Metal Ring- 1200 cc	1200 cc ring bracket for standard metal hospital mount that has no bottom, edging or lip, 1.65" wide (typical use is on anesthesia carts)
71-2096	Bracket, Metal Ring- 1500/2500 cc	1500/2500 cc ring bracket for standard metal hospital mount that has no bottom edging or lip, 1.65" wide (typical use is on anesthesia carts)
71-5008	Bracket, Plastic Ring w/ Valve 1200 cc	Ring bracket for 1200 cc rigid canisters to be used with plastic roll stand or patient floor wall mounts. Bracket includes on/off valve and blue vaccum hose
71-5009	Bracket, Plastic Ring w/ Valve 1500/2500 cc	Ring bracket for 1500/2500 cc rigid canisters to be used with plastic roll stand or patient floor wall mounts. Bracket includes on/off valve and blue vaccum hose
71-5010	Bracket, Plastic Ring, 1200 cc	Plastic single canister ring bracket for 1200 cc canisters, 2" wide, used with existing wall mounts or DeRoyal 71-1116
71-1117	Bracket, Plastic Ring, 1500/2500 cc	Plastic single canister ring bracket for 1500/2500 cc canisters, 2" wide, used with existing wall mounts or DeRoyal 71-1116
71-5018	Bracket, Plastic Ring (Grey), 1500/2500 cc	1500/2500 cc ring bracket w/holes for regulator mount
71-5012	Bracket, Pole Mount	Mount to attach canisters to either a vertical or horizontal pole or handle
71-5017	Bracket, Rail Mount	Universal for Crystalline® ECO Rigid Canisters & SafeLiner® Semi-Rigid Liners
71-5019	Bracket, Rail Mount (Hill-Rom®, Hanging)	Rail mount specific to Hill-Rom® Headwalls to be used with Crystalline® ECO Rigid Canisters and SafeLiner® Semi-Rigid Liners
71-1000T*	Bracket, T Mount	SafeLiner® Semi-Rigid Outer Shell "T Connector" Canister, 1000 cc
71-1500T*	Bracket, T Mount	SafeLiner® Semi-Rigid Outer Shell "T Connector" Canister, 1500 cc
71-3000T*	Bracket, T Mount	SafeLiner® Semi-Rigid Outer Shell "T Connector" Canister, 3000 cc
71-5046	Manifold, 4 Port	Manifold tubing used with plastic roll stand (71-5045)
71-5047	Manifold, 2 Port	Manifold tubing used with plastic roll stand (71-5045)
71-1000BR	Outer Shell Canister, Semi-Rigid, 1000 cc, Bracket Mount	Outer shell for use with SafeLiner® Semi-Rigid 1000 cc liners, sliding bracket mount; fits into standard mounts on plastic roll stand or standard wall brackets
71-1000DS±	Outer Shell Canister, Semi-Rigid, 1000 cc, DISS Mount	Outer shell for use with SafeLiner® Semi-Rigid 1000 cc liners, DISS adapter (polycarbonate) for mounting directly onto regulator
71-1500BR	Outer Shell Canister, Semi-Rigid, 1500 cc, Bracket Mount	Outer shell for use with SafeLiner® Semi-Rigid 1500 cc liners, sliding bracket mount; fits into standard mounts on plastic roll stand or standard wall brackets
71-1500DS±	Outer Shell Canister, Semi-Rigid, 1500 cc, DISS Mount	Outer shell for use with SafeLiner® Semi-Rigid 1500 cc liners, DISS adapter (polycarbonate) for mounting directly onto regulator
71-3000BR	Outer Shell Canister, Semi-Rigid, 3000 cc, Bracket Mount	Outer shell for use with SafeLiner® Semi-Rigid 3000 cc liners, sliding bracket mount; fits into standard mounts on plastic rollstand or standard wall brackets
71-5912	Rollstand Conversion Kit, 1200 cc	Kit required to convert roll stand (71-5045) to accommodate 1200 cc rigid canisters; includes (4) ring brackets (71-5008); (1) manifold (71-2046)
71-5915	Roll Stand Conversion Kit for 1500/2500 cc	Kit required to convert roll stand (71-5045) to accommodate 1500/2500 cc rigid canisters; includes (4) ring brackets (71-5009); (1) manifold (71-5046)

 \*WARNING- This product can expose you to chemicals including Ethylbenzene, which is known to the State or California to cause cancer. For more information, go to [www.P65Warnings.ca.gov](http://www.P65Warnings.ca.gov).

 \*WARNING- This product can expose you to chemicals including 3-Methylcholanthrene, which is known to the State or California to cause cancer. For more information, go to [www.P65Warnings.ca.gov](http://www.P65Warnings.ca.gov).

# Waste Fluid Management

## Suction Hardware & Accessories

Suction Hardware Guide		
Part #	Description	Use/Notes
71-5045	Roll Stand, 4-can, Plastic	Plastic four canister roll stand. Must add adapter kits for the following: 1200 cc- (71-5912); 1500/2500 cc (71-5915); liners (71-5046); manifold + (4) outer shells of correct size
71-5045R	Roll Stand, 4-can, Plastic w/ Regulator Mount	Plastic four canister roll stand. Includes DISS connection on top of roll stand to mount regulator. Must add adapter kits for the following: 1200 cc- (71-5912); 1500/2500 cc (71-5915); liners (71-5046); manifold + (4) outer shells of correct size
71-5045-8	Roll Stand, 8-can, Plastic	Plastic eight canister roll stand. Must add adapter kits for the following: 1200 cc- (71-5912); 1500/2500 cc (71-5915); liners (71-5046); manifold + (4) outer shells of correct size
71-5045-8R	Roll Stand, 8-can, Plastic w/ Regulator Mount	Plastic eight canister roll stand. Includes DISS connection on top of roll stand to mount regulator. Must add adapter kits for the following: 1200 cc- (71-5912); 1500/2500 cc (71-5915); liners (71-5046); manifold + (4) outer shells of correct size
71-5045R-S	Roll Stand, 4-can, Plastic w/ Regulator Mount, Short	Short, plastic four canister roll stand. Includes DISS connection on top of roll stand to mount regulator. Must add adapter kits for the following: 1200 cc- (71-5912); 1500/2500 cc (71-5915); liners (71-5046); manifold + (4) outer shells of correct size
71-5016	Roll Stand, Floor Kick, Double, Universal	Metal double canister roll stand for Crystalline® ECO Rigid Canisters. Must add appropriate ring bracket for rigid canisters or outer shell for liners
71-5013	Wall Mount, Double, Universal, Metal	Metal double wall mount. Can be used to hang 2 canisters or liners from one standard hospital wall mount. Used in combination with the following plastic ring brackets: 71-1117, 71-5008, 71-5009, 71-5010, 71-1000BR, 71-1500BR, 71-3000BR
71-1116	Wall Mount, Plastic	Plastic wall mount used in combination with with the following plastic ring brackets: 71-1117, 71-5008, 71-5009, 71-5010, 71-1000BR, 71-1500BR, 71-3000BR
71-5020	Wall Plate, Metal	Metal wall mount used in combination with with the following plastic ring brackets: 71-1117, 71-5008, 71-5009, 71-5010, 71-1000BR, 71-1500BR, 71-3000BR

# Waste Fluid Management

## Suction Hardware & Accessories



DISS Adapter  
(71-1119±)



Metal DISS  
(71-2100)



Flat Ring Brackets  
(71-5014, 71-2098)



Metal Ring Brackets  
(71-5003, 71-2096)

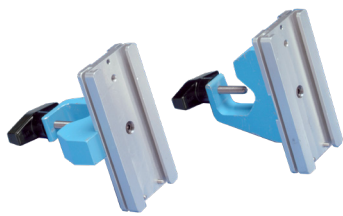

Bracket, Pole Mount  
(71-5012)



Bracket, Plastic Ring w/ On/Off  
Valve (71-5008, 71-5009)



Bracket, Plastic  
(71-5010, 71-1117)



Bracket, Plastic w/ Regulator  
Mount (71-5018)



Bracket, Rail Mount  
(71-5017)



Bracket, Hill-Rom® Rail Mount  
(71-5019)



Bracket, T Mount  
(71-1000T, 71-1500T±, 71-3000T)



Outer Shells for Safeliner®  
Canister, Bracket Mount  
(71-1000BR, 71-1500BR,  
71-3000BR)



Outer Shells for Safeliner®  
Canister, DISS Mount  
(71-1000DS±, 71-1500DS±)

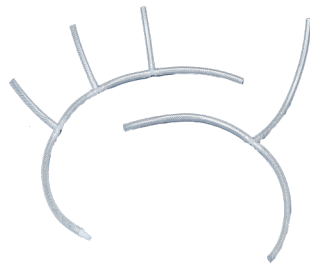

Suction Manifold  
(71-5046, 71-5047)



Roll Stand Conversion Kit  
for Crystalline® Canister  
(71-5912, 71-5915)



Double Wall Mount Adapter  
(71-5013)

 **WARNING-** This product can expose you to chemicals including Ethylbenzene, which is known to the State or California to cause cancer. For more information, go to [www.P65Warnings.ca.gov](http://www.P65Warnings.ca.gov).



# Waste Fluid Management

## Suction Hardware & Accessories



Roll Stand - 4 Can  
(71-5045)



Roll Stand - 4 Can  
w/ Regulator Mount  
(71-5045R)



Roll Stand - 8 Can  
(71-5045-8)



Roll Stand - 8 Can  
w/ Regulator Mount  
(71-5045-8R)



Roll Stand, Short  
(71-5045R-S)



Kick Stand, Double  
(71-5016)



Extended Regulator Mount  
(71-5021)

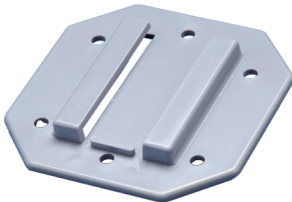

Wall Mount, Plastic  
(71-1116)



Wall Mount, Metal  
(71-5020)

# Surgical Patient Positioners

## Head & Neck



### Round Head Positioners

- Breathable, high-density or low-density foam construction
- Assists in proper alignment of the head, neck, and spine during surgical procedures
- Provides stability, support, and comfort
- Helps protect patient from potential pressure issues and/or tissue breakdown
- Can be used when patient is in supine or lateral positions

Product #	Dimensions	Description	Compression	Qty
M10-091	9" OD x 4½" ID x 1½"	w/o Center	Non-Compressed	36/Cs
M10-091F	9" OD x 4½" ID x 1½"	w/ Center	Non-Compressed	36/Cs
M10-091W	9" OD x 4½" ID x 2"	w/ Center	Non-Compressed	36/Cs
M10-091E	9" OD x 4½" ID x 1½"	w/o Center	Non-Compressed	36/Cs
M10-092	7" OD x 3" ID x 1½"	w/o Center	Non-Compressed	36/Cs
M10-092B	7" OD x 3" ID x 2"	w/ Center	Non-Compressed	36/Cs
M10-092E	7" OD x 3" ID x 1½"	w/o Center	Non-Compressed	36/Cs



### Stacked Head Positioners

- Breathable, high-density foam construction
- Assists in proper alignment of the head, neck, and spine during surgical procedures
- Provides stability, support, and comfort
- Helps protect patient from potential pressure issues and/or tissue breakdown
- Can be used when patient is in supine or lateral positions
- Designed to provide different inner diameters by simply removing inner rings

Product #	Dimensions	Description	Compression	Qty
M10-090	9" OD x (6", 4½", 3" ID) x 2"	Multi Ring	Non-Compressed	36/Cs

### Head Cradle with "T" Cutout

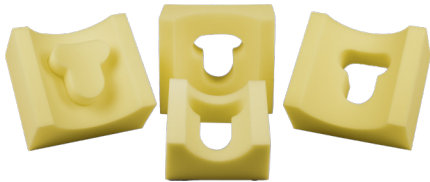

- Breathable, high-density or low-density foam construction
- Assists in proper alignment of the head, neck, and spine during surgical procedures
- Provides stability, support, and comfort
- Helps protect patient from potential pressure issues and/or tissue breakdown
- Can be used when patient is in supine, lateral, or prone positions
- IV slit permits IV line to pass from the equipment to the patient
- "T" cutout allows for secure endotracheal tube placement

Product #	Dimensions	Description	Compression	Qty
M60-023	9½" x 10¾" x 4"	w/ IV Slit	Non-Compressed	10/Cs
M60-023-C	7" x 6¼" x 3½"	Child w/o IV Slit	Compressed	12/Cs
M60-023W	9" x 8" x 4¼"	Cutout Left In	Compressed	12/Cs
M9501	9" x 8" x 4¼"	w/ IV Slit	Compressed	36/Cs
M9501E	9" x 8" x 4¼"	w/ IV Slit	Non-Compressed	36/Cs



## Tall Head Cradle with “T” Cutout

- Breathable, high-density foam construction
- Assists in proper alignment of the head, neck, and spine during surgical procedures
- Provides stability, support, and comfort
- Helps protect patient from potential pressure issues and/or tissue breakdown
- IV slit permits IV line to pass from the equipment to the patient
- “T” cutout allows for secure endotracheal tube placement
- Taller profile provides patients extra comfort and support

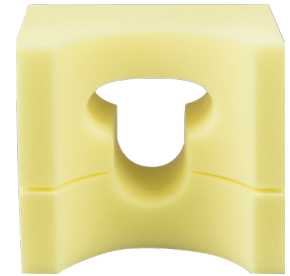

Product #	Dimensions	Description	Compression	Qty
M9503	9" x 8" x 5¾"	w/ IV Slit	Compressed	36/Cs

## Framed Head Positioner

- Breathable, high-density foam construction
- Assists in proper alignment of the head, neck, and spine during surgical procedures
- Provides stability, support, and comfort
- Helps protect patient from potential pressure issues and/or tissue breakdown
- Can be used when patient is in supine, lateral, or prone positions
- IV slit permits IV line to pass from the equipment to the patient
- “T” cutout allows for secure endotracheal tube placement

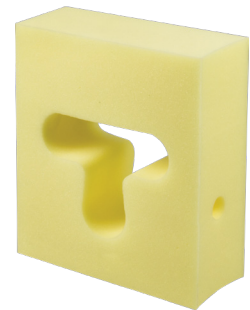

Product #	Dimensions	Description	Compression	Qty
M60-030	10½" x 9½" x 4"	w/ IV Slit	Non-Compressed	10/Cs

## Soft Head Positioner w/ Trach Hole

- Breathable, high-density or low-density foam construction
- Assists in proper alignment of the head, neck, and spine during surgical procedures
- Provides stability, support, and comfort
- Helps protect patient from potential pressure issues and/or tissue breakdown
- Designed with soft top layer for increased comfort



Product #	Dimensions	Compression	Qty
M9504*	10¾" x 9½" x 7"	Compressed	24/Cs
M9504E	10¾" x 9½" x 7"	Non-Compressed	12/Cs
M9505	10" x 10½" x 2½"	Non-Compressed	10/Cs

**⚠️**\*WARNING- This product can expose you to chemicals including Cumene, which is known to the State or California to cause cancer. For more information, go to [www.P65Warnings.ca.gov](http://www.P65Warnings.ca.gov).

# Surgical Patient Positioners

## Head & Neck



### Slotted Head Positioner

- Breathable, high-density foam construction
- Assists in proper alignment of the head, neck, and spine during surgical procedures
- Provides stability, support, and comfort
- Helps protect patient from potential pressure issues and/or tissue breakdown
- Slots provide clearance for breathing or tracheal tubes when patient is placed in a prone position

Product #	Dimensions	Compression	Qty
M60-028	9" x 8" x 4"	Compressed	12/Cs



### Prone Head Positioner

- Breathable, high-density foam construction
- Assists in proper alignment of the head, neck, and spine during surgical procedures
- Provides stability, support, and comfort
- Helps protect patient from potential pressure issues and/or tissue breakdown
- Protects facial features when patient is placed in the prone position
- IV slit permits IV line to pass from the equipment to the patient
- "T" cutout allows for secure endotracheal tube placement

Product #	Dimensions	Compression	Qty
M60-251	8" x 8" x 4"	Compressed	12/Cs



### Prone Head Positioner w/ Arm Support

- Breathable, high-density foam construction
- Assists in proper alignment of the head, neck, and spine during surgical procedures
- Provides stability, support, and comfort
- Helps protect patient from potential pressure issues and/or tissue breakdown
- Protects facial features when patient is placed in the prone position
- Designed to provide comfort and support to patient's forearms

Product #	Dimensions	Compression	Qty
M10-082	20" x 16" x 6"	Non-Compressed	6/Cs

### Ulnar Nerve Protectors

- Breathable, high-density or low-density foam construction
- Designed to protect the elbow and ulnar nerve during surgical procedures
- Provides stability, support, and comfort
- Helps protect patient from potential pressure issues and/or tissue breakdown
- Convoluted foam construction promotes air circulation for patient comfort
- Hook and loop straps for easy application and adjustment

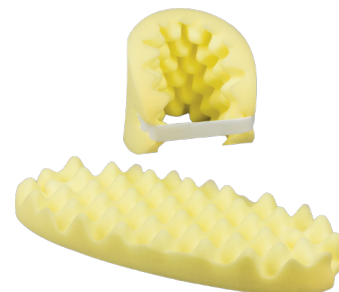

Product #	Dimensions	Compression	Qty
M9500	15½" x 6½"	Non-Compressed	36Pr/Cs
M9500E	15½" x 6½"	Non-Compressed	36Pr/Cs

### Laminectomy Arm Cradle

- Breathable, high-density or low-density foam construction
- Designed to protect the elbow, forearm, and ulnar nerve during surgical procedures
- Provides stability, support, and comfort
- Helps protect patient from potential pressure issues and/or tissue breakdown
- Designed to be flexible allowing the arm to be placed in various positions

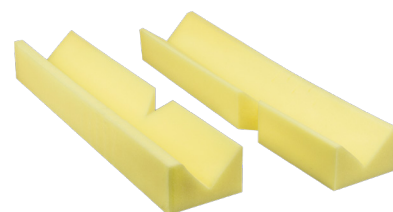

Product #	Dimensions	Compression	Qty
M10-319	24" x 5" x 3"	Compressed	5Pr/Cs
M10-319E	24" x 5" x 3"	Non-Compressed	5Pr/Cs

### Axilla Arm Cuffs

- Breathable foam construction
- Designed to provide support to the upper arm while protecting the axillary vessels and brachial plexus of nerves during surgical procedures
- Helps protect patient from potential pressure issues and/or tissue breakdown
- Can be used in combination with the laminectomy arm cradles

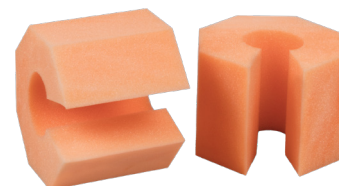

Product #	Dimensions	Compression	Qty
M60-342	6" x 6" x 6"	Non-Compressed	12Pr/Cs

# Surgical Patient Positioners

## Upper Extremity

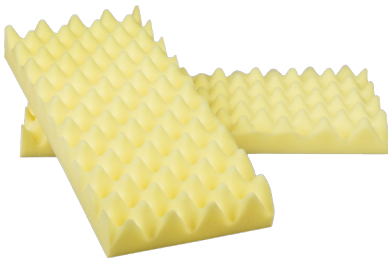

### Convoluted Arm Board Pads

- Breathable, high-density or low-density foam construction
- Designed to protect the elbow, forearm, and ulnar nerve during surgical procedures
- Provides stability, support, and comfort
- Helps protect patient from potential pressure issues and/or tissue breakdown
- Convoluted foam construction promotes air circulation for patient comfort
- Bilateral usage

Product #	Dimensions	Compression	Qty
M10-315	16" x 7½" x 2"	Compressed	12Pr/Cs
M10-312	18" x 7½" x 2"	Non-Compressed	36Pr/Cs
M10-315-36	16" x 7½" x 2"	Non-Compressed	36Ea/Cs
M10-323	20" x 7½" x 2"	Non-Compressed	32Pr/Cs
M10-323E	20" x 7½" x 2"	Non-Compressed	32Pr/Cs
M10-323C	20" x 7½" x 2"	Non-Compressed	32Pr/Cs
M10-314	8" x 8" x 2"	Non-Compressed	48Pr/Cs
M10-325	36" x 8" x 3"	Non-Compressed	12Pr/Cs
M10-328	20" x 12" x 2"	Non-Compressed	12Pr/Cs
M10-324	36" x 8" x 2"	Non-Compressed	12Pr/Cs

### Universal Arm Protector



- Breathable, high-density foam construction
- Designed to protect the elbow, forearm, and ulnar nerve
- Provides stability, support, and comfort
- Helps protect patient from potential pressure issues and/or tissue breakdown
- Convoluted foam construction promotes air circulation for patient comfort
- Hook and loop straps for easy application and adjustment
- Full 360 degree protection

Product #	Dimensions	Compression	Qty
9262-00	23" x 18"	Compressed	12Pr/Cs

### Arm Cradle

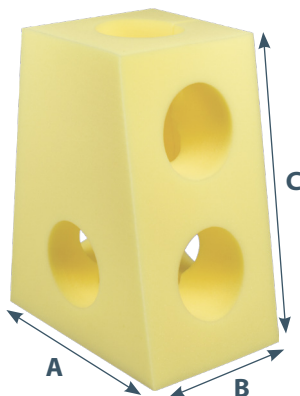

- Breathable, high-density foam construction
- Stabilizes arm in upright position
- Ventilation holes promote air circulation, dissipate heat, and allow use of ice packs to reduce edema

Product #	Dimensions			Compression	Qty
	A	B	C		
M60-034	12½"	9"	15½"	Compressed	5/Cs

# Surgical Patient Positioners

## Lower Extremity

### Leg Positioner w/ 45° Angle

- Breathable, high-density or low-density foam construction
- Provides stability and support for full length of lower extremity
- Gradual incline permits full knee flexion
- Channel is designed to help prevent rotation and unwanted movement
- Slim, concave design helps provide patient comfort

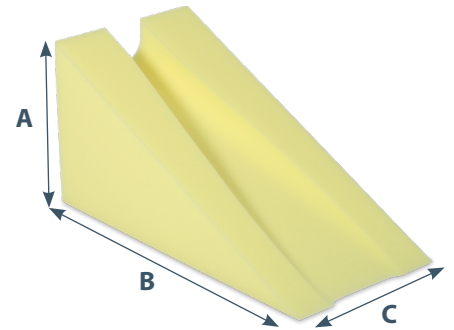

Product #	Dimensions			Compression	Qty
	A	B	C		
M60-070	13"	27"	13"	Compressed	4/Cs
M60-070E	13"	27"	13"	Non-Compressed	2/Cs

### Leg Positioner

- Breathable, high-density foam construction
- Stabilizes knee and lower leg while promoting better circulation
- Foam straps with hook closure for easy application and adjustment

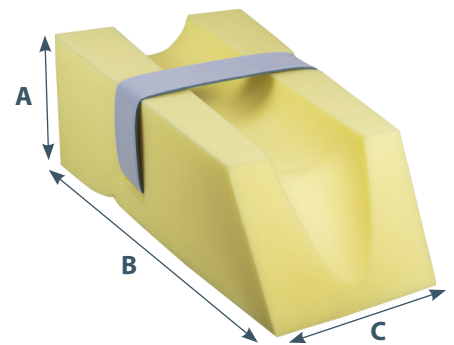

Product #	Dimensions			Compression	Qty
	A	B	C		
M60-015A	11"	29"	11"	Compressed	2/Cs
M60-015B	10"	28"	10"	Compressed	1/CS

### Leg Positioner w/ Foot Drop Strap

- Breathable, high-density foam construction
- Hook receivable foot drop strap holds foot in neutral position
- Stabilizes knee and lower leg while promoting better circulation
- Foam straps with hook closure for easy application and adjustment

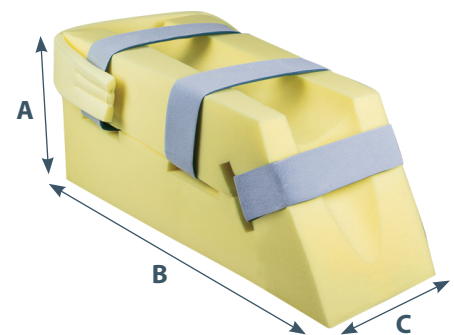

Product #	Dimensions			Compression	Qty
	A	B	C		
M60-015	15"	32"	11"	Compressed	4/Cs

# Surgical Patient Positioners

## Lower Extremity



### Arthroscopic Well-Leg Holder

- Breathable, high-density foam construction
- Designed to support and position the patient's non-affected leg during arthroscopic knee procedures
- Helps protect patient from potential pressure issues and/or tissue breakdown
- Optimizes position and accessibility for surgical procedures

Product #	Dimensions	Compression	Qty
M10-071	10" x 6" x 2"	Compressed	5/Cs

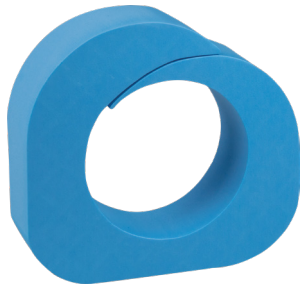

### Arthroscopic Knee Ring

- Breathable, high-density foam construction
- Designed to protect the leg and knee
- Provides stability, support, and comfort
- Helps protect patient from potential pressure issues and/or tissue breakdown

Product #	Dimensions	Compression	Qty
M10-073	11½" x 11" x 3" - 7" opening	Non-Compressed	8/Cs

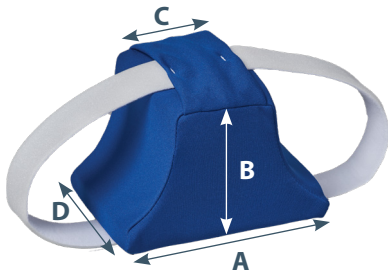

### Knee Wedge

- Breathable, high-density foam construction with polyester cover
- Provides abduction and alignment of legs
- Long foam straps with hook closure for easy application and adjustment

Product #	Dimensions				Compression	Qty
	A	B	C	D		
M60-049	8"	5"	4½"	6"	Compressed	1 Ea

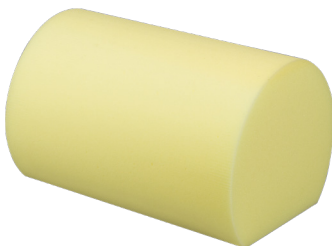

### Knee Roll

- Breathable, high-density foam construction
- Designed to be used in multiple surgical and post-surgical procedures for various positions
- Provides stability, support, and comfort
- Helps protect patient from potential pressure issues and/or tissue breakdown

Product #	Dimensions	Compression	Qty
M60-044	11½" x 7" Diameter	Non-Compressed	9/Cs



## Foot Elevators

- Breathable, high-density foam construction
- Helps maintain proper position while suspending the heel
- Stockinette cover included for patient comfort

Product #	Dimensions	Compression	Qty
M3020-4	4" x 8" x 3½"	Compressed	6Pr/Cs
M3020-6	6" x 8" x 3½"	Compressed	6Pr/Cs



## Foot Cradle

- Breathable, high density foam construction
- Stabilizes foot in upright position
- Ventilation holes promote air circulation, dissipate heat, and allow use of ice packs to reduce edema

Product #	Dimensions	Compression	Qty
M60-045	14" x 9"	Compressed	10/Cs



## Foot Drop Support

- Breathable, high-density foam construction
- Adjustable anti-rotation strap holds foot in neutral position and keeps heel suspended
- Hook receivable foam strap

Product #	Dimensions	Compression	Qty
M60-018	8" x 10"	Compressed	5/Cs





# Surgical Patient Positioners

## Lower Extremity

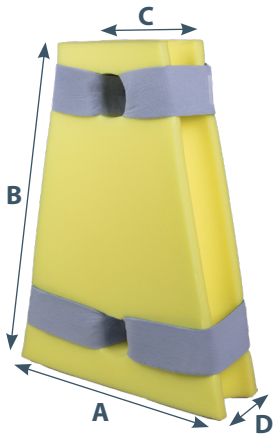

## Concave Hip Abduction Positioner

- Breathable, high-density or low-density foam construction
- Concave sides hold legs in secure position
- Long foam straps with hook closure for easy application and adjustment

Product #	Size	Dimensions				Compression	Qty
		A	B	C	D		
M60-076-XS	X-Small	9"	10"	3"	4"	Compressed	5/Cs
M60-076-S	Small	14"	18"	7"	5"	Compressed	4/Cs
M60-076-M	Medium	16½"	21"	7½"	6"	Compressed	4/Cs
M60-076-L	Large	18"	24"	9"	6"	Compressed	4/Cs

Product #	Size	Dimensions				Compression	Qty
		A	B	C	D		
M60-078-S	Small	14"	18"	7"	5"	Non-Compressed	2/Cs
M60-078-M	Medium	16½"	21"	7½"	6"	Non-Compressed	2/Cs
M60-078-L	Large	18"	24"	9"	6"	Non-Compressed	2/Cs

Product #	Size	Dimensions				Compression	Qty
		A	B	C	D		
M60-076ES	Small	14"	18"	7"	5"	Non-Compressed	2/Cs
M60-076EM	Medium	16"	21"	7½"	6"	Non-Compressed	2/Cs
M60-076EL	Large	18"	24"	9"	6"	Non-Compressed	2/Cs

Product #	Description	Qty
3702D02	Foam Abduction Strap Only	1/Ea

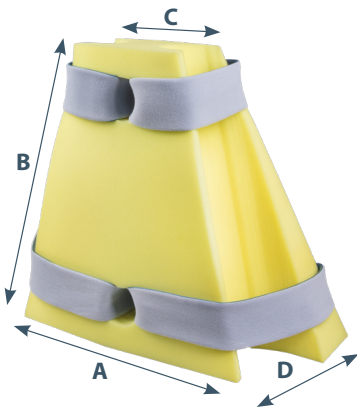

## Concave Hip Abduction Positioner: Wide

- Breathable, high-density foam construction
- Concave sides hold legs in secure position
- Wide angle for increased abduction
- Long foam straps with hook closure for easy application and adjustment

Product #	Size	Dimensions				Compression	Qty
		A	B	C	D		
M60-024-S	Small	16"	16"	10"	7"	Compressed	5/Cs
M60-024-M	Medium	18"	20"	10"	9"	Compressed	5/Cs
M60-024-L	Large	20"	24"	10"	9"	Compressed	5/Cs

# Surgical Patient Positioners

Lower Extremity

## Concave Hip Abduction Positioner: Wide w/ Liner

- Breathable, high-density foam construction
- Concave sides hold legs in secure position
- Wide angle for increased abduction
- Polyfiber liner provides additional patient comfort
- Long foam straps with hook closure for easy application and adjustment

Product #	Size	Dimensions				Compression	Qty
		A	B	C	D		
M60-025-S	Small	16"	16"	10"	7"	Compressed	5/Cs
M60-025-M	Medium	18"	20"	10"	9"	Compressed	5/Cs
M60-025-L	Large	20"	24"	10"	9"	Compressed	5/Cs

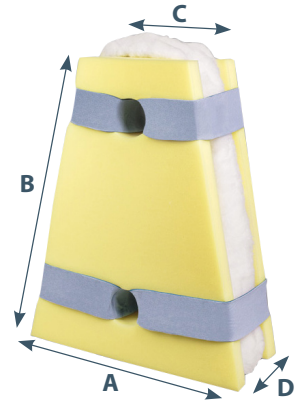

## Flat Hip Abduction Positioner: Wide

- Breathable, high-density foam construction
- Wide angle for increased abduction
- Long foam straps with hook closure for easy application and adjustment

Product #	Size	Dimensions				Compression	Qty
		A	B	C	D		
M60-073-S	Small	14"	17¾"	7"	5¾"	Compressed	3/Cs
M60-073-M	Medium	16½"	17¾"	9"	5¾"	Compressed	3/Cs
M60-073-L	Large	18"	19"	11"	5¾"	Compressed	3/Cs

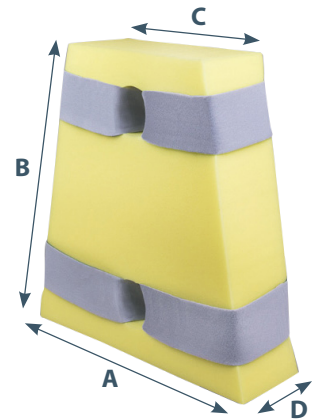

## Concave Hip Abduction Positioner: Narrow

- Breathable, high-density foam construction
- Concave sides hold legs in secure position
- Available with (M60-074) or without (M60-075) polyfiber liner
- Long foam straps with hook closure for easy application and adjustment

Product #	Size	Dimensions				Compression	Qty
		A	B	C	D		
M60-074	Universal	14½"	21½"	5"	6"	Compressed	4/Cs
M60-075	Universal	14½"	21½"	5"	6"	Compressed	4/Cs

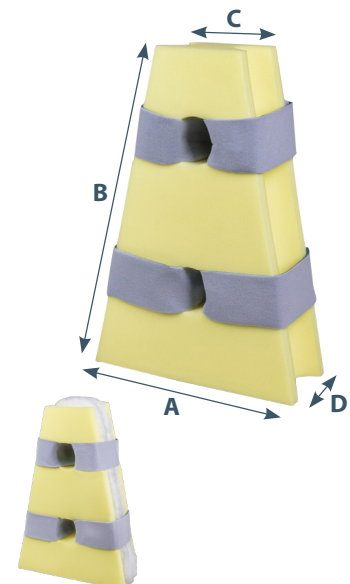

M60-075

# Surgical Patient Positioners

## Lower Extremity

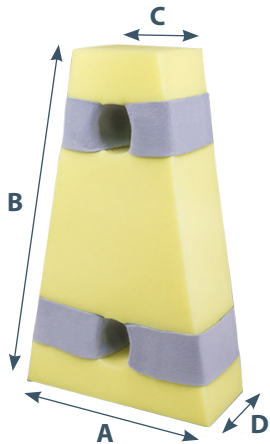

### Flat Hip Abduction Positioner: Narrow

- Breathable, high-density foam construction
- Long foam straps with hook closure for easy application and adjustment

Product #	Size	Dimensions				Compression	Qty
		A	B	C	D		
M60-031-S	Small	10"	16"	6"	7"	Compressed	5/Cs
M60-031-M	Medium	12"	21"	6"	7"	Compressed	5/Cs
M60-031-L	Large	14"	23"	6"	7"	Compressed	5/Cs

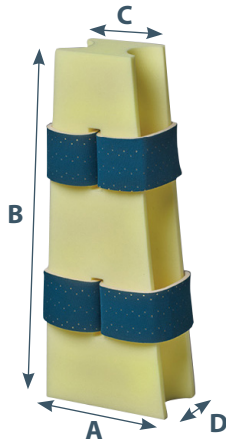

### Hip Abduction Positioner: Adjustable

- Breathable, high-density foam construction
- Concave sides hold legs in secure position
- 4" tear-off blocks on both ends for length adjustment
- Long, perforated foam straps with hook closure for easy application and adjustment

Product #	Size	Dimensions				Compression	Qty
		A	B	C	D		
M60-224	Universal	10¼"	18" - 26"	6"	5"	Compressed	4/Cs

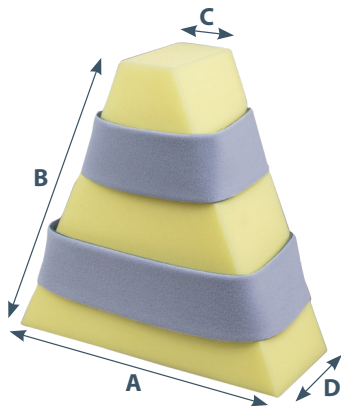

### Hip Abduction Positioner: Full

- Breathable, high-density foam construction
- Full foam design provides additional stability
- Long foam straps with hook closure for easy application and adjustment

Product #	Size	Dimensions				Compression	Qty
		A	B	C	D		
M60-070M	Medium	15"	15"	3"	6"	Compressed	4/Cs
M60-070L	Large	17"	19"	6"	6"	Compressed	4/Cs

# Surgical Patient Positioners

Lower Extremity

## Vinyl Covered Hip Abduction Positioner

- High-density foam construction with vinyl cover wipes clean for easy disinfecting
- Soft, cotton liner for patient comfort
- Elasticized, foam covered straps with hook and loop closure for easy application and adjustment
- Liner and straps are available separately

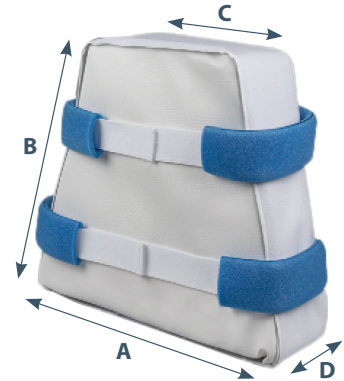

Product #	Size	Dimensions			Compression	Qty	
		A	B	C			
9219-01*	Small	14"	17¾"	7"	5¾"	Non-Compressed	1/Ea
9219-02*	Medium	16"	17¾"	9"	5¾"	Non-Compressed	1/Ea
9219-03*	Large	20"	17¾"	11½"	5¾"	Non-Compressed	1/Ea

Product #	Description	Qty
9219-00	Liner and straps	1 Set

## Utility Rolls

- Breathable, high-density foam construction
- Designed to be used in multiple surgical and post-surgical procedures for various positions
- Provides stability, support, and comfort
- Helps protect patient from potential pressure issues and/or tissue breakdown



Product #	Dimensions	Compression	Qty
M10-093	12" x 4¾"	Non-Compressed	1/Ea
M10-094	17" x 4¾"	Non-Compressed	6/Cs
M10-095	12" x 7"	Non-Compressed	1/Ea

## Convoluted Overlay Pads

- Breathable, high-density foam construction
- Designed to be used in multiple surgical and post-surgical procedures for various positions
- Provides stability, support, and comfort
- Helps protect patient from potential pressure issues and/or tissue breakdown
- Convoluted foam construction promotes air circulation for patient comfort



Product #	Dimensions	Compression	Qty
M15-2072R	72" x 20" x 2"	Non-Compressed	6/Cs
M15-2075	73" x 21" x 4"	Non-Compressed	4/Cs
M15-2074	42" x 20" x 3"	Compressed	12/Cs
M15-2076	73" x 35" x 2"	Non-Compressed	10/Cs
M15-2077	73" x 32" x 3"	Non-Compressed	8/Cs

**!** \*WARNING- This product can expose you to chemicals including Diisononyl Phthalate, which is known to the State or California to cause cancer. For more information, go to [www.P65Warnings.ca.gov](http://www.P65Warnings.ca.gov).

# Surgical Patient Positioners

## OR Table Pads and Accessories

### Positioning Pads



- Breathable, high-density foam construction
- Designed to be used in multiple surgical and post-surgical procedures for various positions
- Provides stability, support, and comfort
- Helps protect patient from potential pressure issues and/or tissue breakdown
- Pressure-reducing device for all purposes

Product #	Dimensions	Compression	Qty
M10-049	20" x 6½" x ¾"	Non-Compressed	105/Cs
M10-321	10" x 8" x ¾"	Non-Compressed	15/Cs

### OR Table Strap



- Assists in securing patient during surgical procedures
- Reduces chance of injury due to unwanted movement
- Soft, breathable foam construction for patient comfort
- Hook and loop closure for easy application and adjustment

Product #	Dimensions	Closure	Qty
M5173	72" x 5"	Hook and Loop	50/Cs

### OR Table Strap



- Designed for OR tables and gurneys
- Assists in securing patient during surgical procedures
- Reduces chance of injury due to unwanted movement
- Adjustable to accommodate different bed types and sizes
- Hook and loop closure for easy application and adjustment

Product #	Dimensions	Closure	Qty
M5182	93" x 2" Adjustable	Hook and Loop	50/Cs

### OR Table Strap

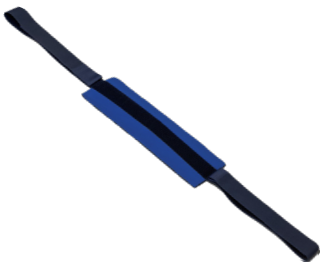

- Designed for OR tables and gurneys
- Assists in securing patient during surgical procedures
- Reduces chance of injury due to unwanted movement
- Middle padding for maximum patient comfort and protection
- Hook and loop closure for easy application and adjustment

Product #	Dimensions	Closure	Qty
M5183	70" w/Middle Pad	Hook and Loop	50/Cs

### Body Holder/OR Table

- Designed for OR tables and gurneys
- Assists in securing patient during surgical procedures
- Reduces chance of injury due to unwanted movement
- Metal D-rings allow for easy attachment to OR tables or gurneys
- Hook and loop closure for easy application and adjustment
- 2-piece body strap



Product #	Dimensions	Closure	Qty
M5178	30" x 3 <sup>3</sup> / <sub>8</sub> "	Hook and Loop	50/Cs

### Adjustable OR Table Strap

- Designed for OR tables and gurneys
- Assists in securing patient during surgical procedures
- Reduces chance of injury due to unwanted movement
- Soft, breathable foam construction for patient comfort
- Hook and loop closure for easy application and adjustment



Product #	Dimensions	Closure	Qty
M9352-D	60" x 2 <sup>1</sup> / <sub>4</sub> "	Hook and Loop	12/Cs

### OR Table Straps/Positioners

- Designed for OR tables and gurneys
- Assists in securing patient during surgical procedures
- Reduces chance of injury due to unwanted movement
- Soft, breathable foam construction for patient comfort
- Hook and loop closure for easy application and adjustment



Product #	Dimensions	Closure	Qty
M5175	22" x 1 <sup>7</sup> / <sub>8</sub> "	Hook and Loop	50/Cs
M5180	36" x 1 <sup>7</sup> / <sub>8</sub> "	Hook and Loop	50/Cs

# Surgical Patient Positioners

## OR Table Pads and Accessories



### Surgical Leg Holder

- Designed to allow leg to be suspended while foot is secured
- Constructed from durable yet soft non-woven material
- Double looped with foam padding to ensure patient comfort
- Double D-ring allows for easy attachment and secure placement

Product #	Description	Qty
M4212D04	Stirrup Set, Non-Woven	12/Cs



### Surgical Leg Holder

- Designed to allow leg to be suspended while foot is secured
- Constructed from durable yet soft webbing material
- Double looped to ensure patient comfort
- Double D-ring allows for easy attachment and secure placement

Product #	Description	Qty
M5131	Stirrup Set, Soft Webbing	12/Cs



### Surgical Chin Strap

- Designed for OR tables and gurneys
- Assists in securing patient during surgical procedures
- Reduces chance of injury due to unwanted movement
- Middle padding to increase patient comfort and protection
- Hook and loop closure for easy application and adjustment

Product #	Description	Qty
M5179	Chin Strap	25/Cs



# Surgical Patient Positioners

## Body Aligners

### Body Aligner

- Breathable, high-density or low-density foam construction
- Helps maintain proper positioning while reducing pressure from sacrum
- Available in compressed packaging for efficient storage or non-compressed option

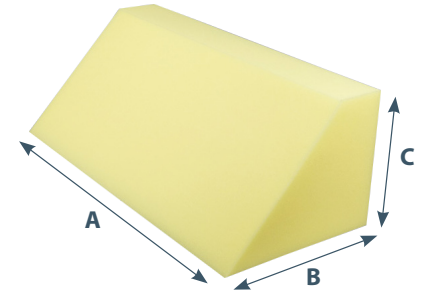

Product #	Dimensions			Degree	Compression	Qty
	A	B	C			
M10-083E	23"	9½"	5"	34°	Non-Compressed	12/Cs
M30-640	24"	8½"	11"	60°	Compressed	5/Cs
M60-031	12"	11"	4"	25°	Compressed	20/Cs
M60-032	24"	11"	8½"	45°	Compressed	5/Cs
M60-032A	18"	11"	8"	42°	Compressed	6/Cs
M60-032B	24"	11"	8½"	45°	Compressed	10/Cs
M60-032E	21"	10½"	8"	43°	Non-Compressed	6/Cs
M60-033	26"	27"	12"	25°	Non-Compressed	2/Cs
M60-061E	20"	10"	6"	35°	Non-Compressed	6/Cs
M60-063	22"	11"	6"	15°	Compressed	5/Cs
M60-230	22"	11"	8"	20°	Non-Compressed	8/Cs

### Covered Body Aligner

- Breathable, high-density foam construction
- Helps maintain proper positioning while relieving pressure from sacrum
- Cover is water and stain resistant with wipeable surface
- Anti-skid bottom helps keep body aligner in place

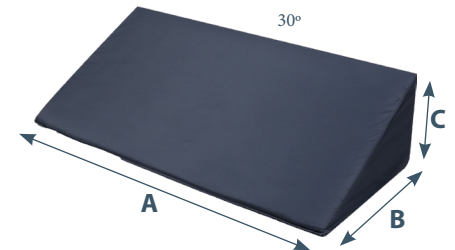

Product #	Dimensions			Degree	Compression	Qty
	A	B	C			
M60-032D	24"	11½"	6½"	30°	Non-Compressed	4/Cs

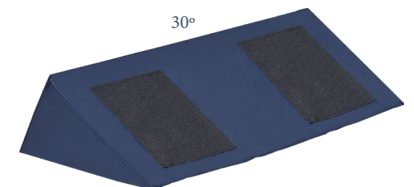

Anti-skid Bottom

# Surgical Patient Positioners

## Multi-Angle Patient Positioning System

### STEEP-T® Multi-Angle Patient Positioning System

- Provides patient fixation for any procedure that requires steep angulation of the operative table
- A solution for multi-specialty surgical applications
- Helps to prevent unwanted movement or slippage of the patient during table position changes as well as prolonged periods of fixed steep angulation
- Quick and easy set up
- Single-use foam pad with straps may be used to gently reposition the patient on the OR table, as needed, for pre-operative changes

#### M60-SF500 Kit



**Product #**  
M60-SF500

**Description**  
Kit Includes:  
Foam Lift Pad  
Table Strap

**Qty**  
6/Cs  
1 Ea/Kit  
1 Ea/Kit

#### M60-SF501 Kit



**Product #**  
M60-SF501

**Description**  
Kit Includes:  
Foam Lift Pad  
Head Positioner  
Scapular Wedges  
Arm Protectors  
Body Strap  
Table Strap

**Qty**  
3/Cs  
1 Ea/Kit  
1 Ea/Kit  
1 Pr/Kit  
1 Pr/Kit  
1 Ea/Kit  
1 Ea/Kit

#### M60-SF502 Kit



**Product #**  
M60-SF502

**Description**  
Kit Includes:  
Foam Lift Pad  
Scapular Wedges  
Arm Protectors  
Body Strap  
Table Strap

**Qty**  
3/Cs  
1 Ea/Kit  
1 Pr/Kit  
1 Pr/Kit  
1 Ea/Kit  
1 Ea/Kit

# Surgical Patient Positioners

Multi-Angle Patient Positioning System

## M60-SF503 Kit

**Product #**  
M60-SF503

**Description**  
Kit Includes:  
Foam Lift Pad  
Body Strap  
Table Strap

**Qty**  
5/Cs  
1 Ea/Kit  
1 Ea/Kit  
1 Ea/Kit



## M60-SF505 Kit

**Product #**  
M60-SF505

**Description**  
Kit Includes:  
Foam Lift Pad  
Head Positioner  
Arm Protectors  
Lift Sheet  
Body Strap  
Table Strap

**Qty**  
3/Cs  
1 Ea/Kit  
1 Ea/Kit  
1 Pr/Kit  
1 Ea/Kit  
1 Ea/Kit  
1 Ea/Kit



## Anti-Skid OR Table Pad

- Non-skid backing creates an interlocking action for superior fixation

**Product #**  
M60-SF510F

**Description**  
O.R. Table Pad- Flat

**Qty**  
1 Ea/Cs



# Surgical Patient Positioners

## Positioning Kits

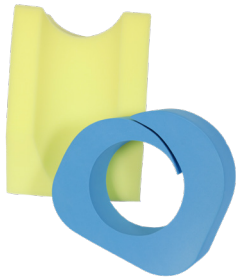

### Arthroscopy Knee Positioning Kit

Product #	Description	Qty
M60-374	Compressed Kit Includes: Well-leg Holder (M10-071) Arthroscopic Knee Ring (M10-073)	10/Cs 1 Ea/Kit 1 Ea/Kit

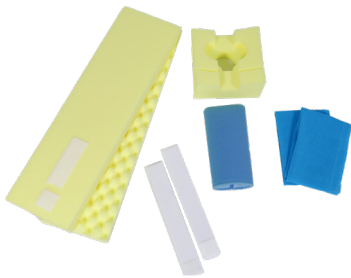

### Hana® Table Style Kit

Product #	Description	Qty
M60-361	Compressed Kit Includes: Convoluted Armboard Pads w/Straps Slotted Head Positioner Ball Joint Cover Perineal Post Covers	6/Cs 1 Pr/Kit 1 Ea/Kit 1 Ea/Kit 2 Ea/Kit

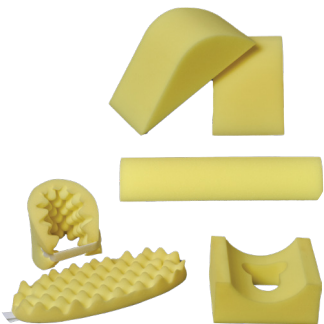

### Positioning Kit w/Leg Elevation (Open Heart)

Product #	Description	Qty
M60-331	Compressed Kit Includes: Head Cradle (M60-023) Utility Roll Half Ulnar Nerve Protectors (M9500) Knee Positioners	10/Cs 1 Ea/Kit 1 Ea/Kit 1 Pr/Kit 1 Pr/Kit

## Laminectomy Arm Cradle

Product #	Description	Qty
M60-340	Non-Compressed Kit Includes: Laminectomy Arm Cradles (M10-319E) Axilla Cuff (M60-342)	5/Cs 1 Pr/Kit 1 Pr/Kit

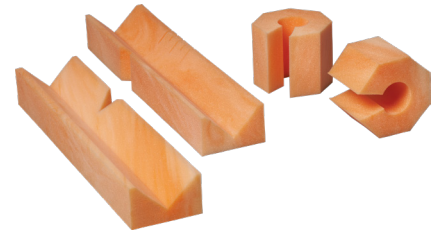

## Laminectomy Positioning Kits

Product #	Description	Qty
M60-318	Compressed Kit Includes: Head Cradle (M60-023) Laminectomy Arm Cradles (M10-319)	12/Cs 1 Ea/Kit 1 Pr/Kit
M60-319	Compressed Kit Includes: Head Cradle (M60-023) Laminectomy Arm Cradles (M10-319) Arm Board Pads (M10-308)	12/Cs 1 Ea/Kit 1 Pr/Kit 1 Pr/Kit

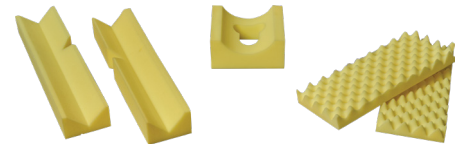

## Prone Patient Positioning Kit

- Helps reduce risk of hospital acquired pressure injuries
- Aids in safe consistent alignment of patient
- Can be used for ICU prone patient positioning

Product #	Description	Qty
M60-360	Compressed Kit Includes: Head Positioner (10" x 10½" x 2½" with "T" cutout) Standard Foam Pads (8" x 11" x 1") Large Foam Pad (15" x 11" x 1") Shin Positioners (9" x 6" Semicircular)	5/Cs 1 Ea/Kit 1 Pr/Kit 1 Ea/Kit 1 Pr/Kit

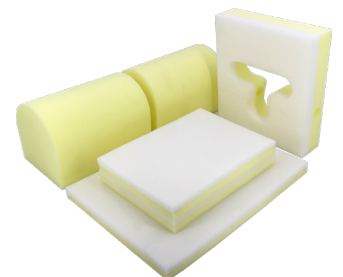

# Surgical Patient Positioners

DeRoyal® Patient Positioning Kits

## Jackson Table Style Kit 1



**Product #**  
M60-337\*

**Description**  
Compressed Kit Includes:  
Chest Positioner (M9601)  
Hip & Thigh Pad Covers  
Soft Head Positioner (M9504\*)  
Laminectomy Arm Cradles

**Qty**  
12/Cs  
1 Ea/Kit  
4 Ea/Kit  
1 Ea/Kit  
1 Pr/Kit

## Jackson Table Style Kit 2



**Product #**  
M60-339

**Description**  
Compressed Kit Includes:  
Chest Positioner (M9601)  
Hip & Thigh Pad Covers  
Laminectomy Arm Cradles

**Qty**  
12/Cs  
1 Ea/Kit  
4 Ea/Kit  
1 Pr/Kit

## Jackson Table Style Kit 3



**Product #**  
M60-336\*

**Description**  
Compressed Kit Includes:  
Chest Positioner (M9601)  
Hip & Thigh Pad Covers  
Soft Head Positioner (M9504\*)

**Qty**  
12/Cs  
1 Ea/Kit  
4 Ea/Kit  
1 Ea/Kit

## Jackson Table Style Kit 4



**Product #**  
M60-346

**Description**  
Compressed Kit Includes:  
Chest Positioner (M9601)  
Hip & Thigh Pad Covers

**Qty**  
12/Cs  
1 Ea/Kit  
4 Ea/Kit

## Jackson Table Style Kit 5



**Product #**  
M60-355

**Description**  
Compressed Kit Includes:  
Chest Positioner (M9601)  
Hip & Thigh Pad Covers  
Laminectomy Arm Cradles

**Qty**  
12/Cs  
2 Ea/Kit  
4 Ea/Kit  
1 Pr/Kit

 \*WARNING- This product can expose you to chemicals including Cumene, which is known to the State of California to cause cancer. For more information, go to [www.P65Warnings.ca.gov](http://www.P65Warnings.ca.gov).

# Surgical Patient Positioners

DeRoyal® Patient Positioning Kits

## Wilson Table Style Kit 1

**Product #**  
M60-341\*

**Description**  
Compressed Kit Includes:  
Soft Head Positioner (M9504\*)  
Laminectomy Arm Cradles (M10-319)  
Sleeves  
Transverse Bar Cover  
Base Cover

**Qty**  
12/Cs  
1 Ea/Kit  
1 Pr/Kit  
1 Pr/Kit  
1 Ea/Kit  
1 Ea/Kit

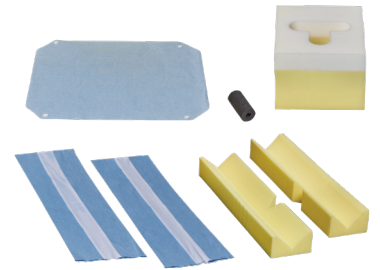

## Wilson Table Style Kit 2

**Product #**  
M60-348

**Description**  
Compressed Kit Includes:  
Laminectomy Arm Cradles (M10-319)  
Sleeves  
Transverse Bar Cover  
Base Cover

**Qty**  
12/Cs  
1 Pr/Kit  
1 Pr/Kit  
1 Ea/Kit  
1 Ea/Kit

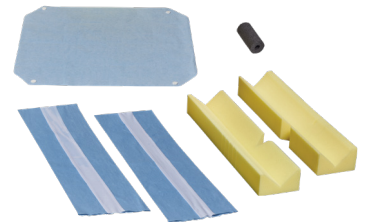

## Wilson Table Style Kit 3

**Product #**  
M60-345\*

**Description**  
Compressed Kit Includes:  
Soft Head Positioner (M9504\*)  
Sleeves  
Transverse Bar Cover  
Base Cover

**Qty**  
12/Cs  
1 Ea/Kit  
1 Pr/Kit  
1 Ea/Kit  
1 Ea/Kit



## Wilson Table Style Kit 4

**Product #**  
M60-347

**Description**  
Compressed Kit Includes:  
Sleeves  
Transverse Bar Cover  
Base Cover

**Qty**  
12/Cs  
1 Pr/Kit  
1 Ea/Kit  
1 Ea/Kit



 \*WARNING- This product can expose you to chemicals including Cumene, which is known to the State or California to cause cancer. For more information, go to [www.P65Warnings.ca.gov](http://www.P65Warnings.ca.gov).



# Surgical Patient Positioners

DeRoyal® Patient Positioning Kits

## Andrews Frame Style Kit 1



**Product #**  
M60-334

**Description**  
Compressed Kit Includes:  
Torso Lift Sheet  
Seat Cover  
Prone Head Cradle (M9503)  
Foam Heel/Ankle Protectors (M190FF)  
Frame Strap

**Qty**  
12/Cs  
1 Ea/Kit  
1 Ea/Kit  
1 Ea/Kit  
1 Pr/Kit  
1 Ea/Kit

## Schlein Beach Chair Style Kit



**Product #**  
M60-325

**Description**  
Compressed Kit Includes:  
Backrest Pad  
Headrest Pad  
Torso Strap  
Forehead Strap  
Chin Strap (M5179)

**Qty**  
12/Cs  
1 Ea/Kit  
1 Ea/Kit  
1 Ea/Kit  
1 Ea/Kit  
1 Ea/Kit

## Bariatric Supine Positioning Kit



**Product #**  
M60-350

**Description**  
Compressed Kit Includes:  
Soft Head Positioner  
Arm Positioners w/Straps  
Leg Positioners

**Qty**  
4/Cs  
1 Ea/Kit  
1 Pr/Kit  
1 Pr/Kit

### Electrosurgical Pencils

- Hand-activated electrosurgical pencils
- Three-prong plug fits most electrosurgical generators
- Available in 10' and 15' cords for easy set up and drapeability
- PTFE coated electrodes designed to reduce tissue adhesion
- Single use only
- Not made with natural rubber latex

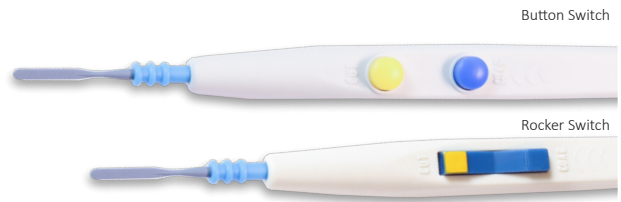

Sterile Uncoated	Sterile PTFE Coated	Non-Sterile PTFE Coated	Non-Sterile Uncoated
88-000031	88-000041±	88-000003	88-000006±
88-000032	88-000042	88-000004	88-000007
88-000001	88-000021±	—	—
88-000002	88-000022	—	—
88-001501	88-001521	—	—
88-001502	—	—	88-101502
88-000051	—	—	—
88-000052	—	—	—
88-000222	—	—	—
88-000008	—	—	—

#### Description

- Rocker Switch Pencil
- Button Switch Pencil
- Rocker Switch Pencil w/ Holster
- Button Switch Pencil w/ Holster
- Rocker Switch Pencil w/ 15' Cord, Holster
- Button Switch Pencil w/ 15' Cord, Holster
- Rocker Switch Pencil w/ Holster, Tip Cleaner
- Button Switch Pencil w/ Holster, Tip Cleaner
- Button Switch Pencil w/ 1" Needle, Holster
- Holster

Sterile, 50 Ea/Cs

All Non-Sterile pencils are 100/Cs, holster sold separately

### Suction Coagulators

- Increased efficiency during procedures requiring controlled fluid evacuation
- Suction and coagulation can be performed independently or simultaneously
- Available in foot switching or hand switching “coag” activation options
- Vented handle for suction control
- Handle is ergonomically designed to provide a sure grip when wet and improve tactile sensitivity
- Flexible configuration allows clinician to match instruments to specific surgical needs
- Single use only
- Not made with natural rubber latex
- Sterile



KW-30-5200

Product #	Description	Qty
KW-30-5200*	10 FR Suction Coagulator w/ Hand Switch Activation	1/Pk, 10 Pks/Cs
88-2505-10FR*	10 FR Suction Coagulator w/ Foot Switch Activation	1/Pk, 10 Pks/Cs

**⚠️**WARNING- This product can expose you to chemicals including Nickel(Metallic), which is known to the State or California to cause cancer, and Lead, which is known to the State or California to cause birth defects or other reproductive harm. For more information, go to [www.P65Warnings.ca.gov](http://www.P65Warnings.ca.gov).

**⚠️**\*WARNING- This product can expose you to chemicals including di(2-ethylhexyl)phthalate, which is known to the State of California to cause cancer and birth defects or other reproductive harm. For more information, go to [www.P65Warnings.ca.gov](http://www.P65Warnings.ca.gov).

# Electrosurgical

## Electrodes

### Single-Use Electrodes

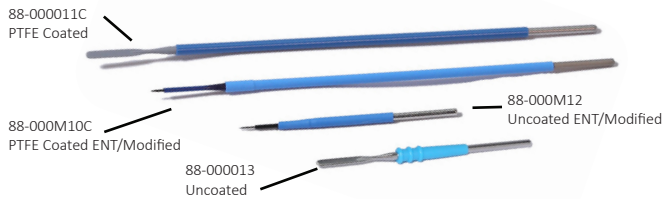

- Product offering includes most widely used blades, needles, and ball electrodes for specific applications
- PTFE coated electrodes designed to reduce tissue adhesion
- Available in regular and extended lengths
- ENT/Modified versions available in coated or stainless steel
- Single use only
- Not made with natural rubber latex
- Sterile

Uncoated	ENT/Modified Uncoated	PTFE Coated	ENT/Modified PTFE Coated	Description	Qty
88-000013	88-000M13	88-000013C	88-000M13C	1" Blade Electrode	1/Pk, 25 Pks/Cs
88-000012	88-000M12	88-000012C	88-000M12C	1" Needle Electrode	1/Pk, 25 Pks/Cs
88-000011	88-000M11	88-000011C	88-000M11C	6" Blade Electrode	1/Pk, 25 Pks/Cs
88-000010	—	—	88-000M10C	6" Needle Electrode	1/Pk, 25 Pks/Cs
—	—	88-000015C	—	4" Blade Electrode	1/Pk, 25 Pks/Cs

### Micro Needles



- Precision in cutting and coagulation without the expense of a laser
- Ultra-sharp tip allows use of extremely low wattage
- Tungsten tip for heat resistance
- Insulated within 3 mm of tip to allow deep tissue access without the risk of accidental burns
- Single use only
- Not made with natural rubber latex
- Sterile

Product #	Description	Qty
88-103	3 cm Micro Needle Electrode	10/Cs
88-104A	4 cm Micro Needle Electrode	10/Cs

### Arthroscopic Electrodes



- For use in arthroscopic procedures where irrigating solutions are used in conjunction with an electrosurgical pencil
- Insulation extends to the electrode tip for precise energy delivery
- Transparent insulation improves surgeon's tip visualization
- Stabilizing electrode cap ensures a safe connection from electrode to pencil
- Compatible with all pencils for ease of conversion
- 6½" (16.51 cm) length
- Single use only
- Not made with natural rubber latex
- Sterile

Product #	Description	Qty
88-1510	Insulated Arthroscopic Hook, 90°	10/Cs
88-1512	Insulated Arthroscopic Angled Blade, 90°	10/Cs
88-2510*	Rocker Pencil w/ 88-1510 Electrode	10/Cs
88-2512*	Rocker Pencil w/ 88-1512 Electrode	10/Cs
88-2610	Push Button Pencil w/ 88-1510 Electrode	10/Cs

**⚠️ WARNING**- This product can expose you to chemicals including Nickel (Metallic), which is known to the State or California to cause cancer, and Lead, which is known to the State or California to cause birth defects or other reproductive harm. For more information, go to [www.P65Warnings.ca.gov](http://www.P65Warnings.ca.gov).

### FlexiPad™ and Adhesive Gel Dispersive Electrodes

- Strong adhesion, yet gentle removal
- Standard plugs work with most electrosurgical generators
- Flexible cord for easy set up and drapeability
- Impermeable foam backing and non-conductive adhesive border securely seal out fluids creating a moisture-safe barrier
- Thin, flexible hydrogel or adhesive gel pad conforms to a variety of anatomical sites and allows easy removal without pulling hair or injury to skin
- FlexiPad™ electrode has a unique shape and advanced hydrogel adhesive to better conform and adhere to body contours
- Single use only
- Not made with natural rubber latex



Adhesive Gel Electrode  
88-000202

FlexiPad™	Adhesive Gel	Description	Qty
—	88-000201	Adult Mono/Standard Pad	1/Pk, 50 Pks/Bx, 1 Bx/Cs
88-104	88-000202	Adult Dual Conductor Pad	1/Pk, 50 Pks/Bx, 1 Bx/Cs

### Hydrogel

- Strong adhesion with gentle removable hydrogel is compatible with most skin types
- Standard 3-prong plug fits most major brands of generators
- 10' preattached cord for convenience and ease of use
- Not made with natural rubber latex
- Non-Sterile



88-000102

Product #	Description	Size	Qty
88-000102	Dual Conductor (REM) Pad w/ 10' Cord	Adult	100/Cs

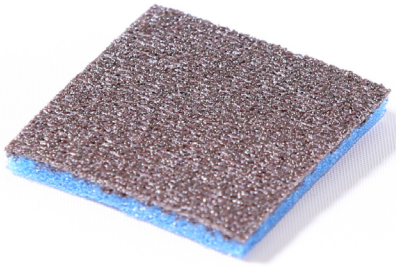

### Electrode Tip Cleaner

- A convenient debris removal system
- Coated scratch pad for quick and easy cleaning of instrument tips
- Radiopaque element ensures x-ray detectability
- Adhesive backing securely holds on draped surface
- Single use only
- Not made with natural rubber latex
- Sterile

Product #	Description	Qty
32-200	1.8" x 1.7" Tip Cleaner	1/Pk, 25 Pks/Bx, 4 Bxs/Cs
30-200	1.8" x 1.7" Tip Cleaner	1/Pk, 240 Pks/Cs



### Disposable Bipolar Cord

- For use in conjunction with ophthalmic/neurosurgical microsurgical bipolar forceps
- Single use only
- Not made with natural rubber latex
- Sterile

Product #	Description	Qty
88-001000	12' Bipolar Cord, Sterile	1/Pk, 10 Pks/Cs

### ExtendEVAC® Smoke Evacuation Pencils

- Integrated into button switch pencil for use with wall suction or any smoke evacuator machine
- Clear tip allows visualization of entire electrode tip
- Revolutionary low-profile ExtendEVAC® pencil with integral telescoping smoke evacuation tip
- Telescoping feature allows electrode to be adjusted from 1" to 6", saving time and money
- Telescoping smoke evacuation remains close to cautery site for optimum performance
- Soft tubing with swivel for ease of use
- ENT version with clear narrow telescoping tip for tight spaces
- Single use only
- Not made with natural rubber latex
- Sterile

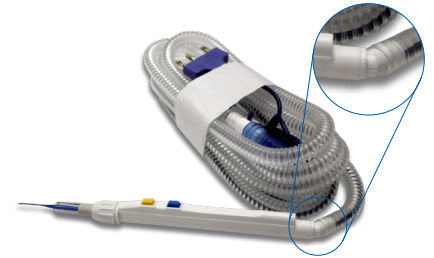

Product # Uncoated	Product # Coated	Description	Qty
88-000702	88-000722	ExtendEVAC™ 10' Tubing 3/8" Diameter, Holster	1/Pk, 25 Pks/Bx, 1 Bx/Cs
—	88-015722	ExtendEVAC™ w/ 15' Cord, 10' Tubing 3/8" Diameter, Holster	1/Pk, 25 Pks/Bx, 1 Bx/Cs
—	88-000725	ExtendEVAC™ PTFE Blade, 10' Tubing 3/8" Diameter, Holster	1/Pk, 10 Pks/Bx, 1 Bx/Cs

### Smoke Evacuation Attachment

- Universal smoke evacuation attachments and accessories
- Universal snap-on sheath attachments convert standard pencil into a smoke evacuation pencil
- Fits all electrosurgical pencils available on market
- Single use only
- Not made with natural rubber latex
- Sterile

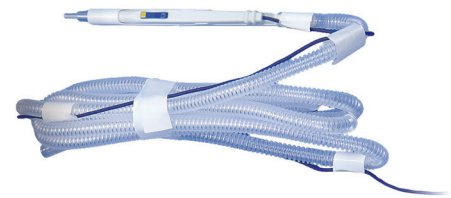

Product #	Description	Qty
88-000600	Universal Smoke Evacuation Attachment w/ 10' Tubing 3/8" Diameter	1/Pk, 25 Pks/Bx, 1 Bx/Cs

### Insufflation Tubing Sets

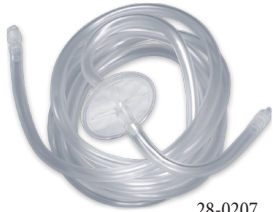

28-0207



28-0212H



28-0209



28-0211

- Adaptable to most insufflators for tubing standardization
- Color-coded tubing aids in setup
- Rotating luer-lock connector prevents twisting or disconnects of CO<sup>2</sup> line
- Durable, non-collapsing tubing
- Bi-directional .1 or .3 micron filters reduce the chance of contamination
- High-flow filter available that will not inhibit pneumoperitoneum
- Not made with natural rubber latex
- Available in 10' tubing length
- Sterile
- For non-sterile bulk offering, add NS to product number

#### .1 Micron Filter, Low Flow

Product #	Description	Qty
28-0201	Color Coded Insufflation Tubing	20/Cs
28-0207	Clear Insufflation Tubing	20/Cs
28-0209	Clear Insufflation Tubing w/ Quick Connect Fitting	20/Cs

#### .3 Micron Filter, High Flow

Product #	Description	Qty
28-0210	Insufflation Tubing	20/Cs
28-0211	Insufflation Tubing w/ Stryker® Fitting	20/Cs
28-0212	Insufflation Tubing w/ Karl Storz™ Fitting	20/Cs
28-0212H	Heated, Insufflation Tubing w/ Karl Storz™ Fitting	20/Cs
28-0213	Insufflation Tubing w/ Quick Connect Fitting	20/Cs
28-0214	Insufflation Tubing w/o Fitting	20/Cs
28-0216	Insufflation Tubing w/ Linvatec® Fitting	20/Cs
28-0217	Insufflation Tubing w/ Richard Wolf™ Fitting	20/Cs

### Insufflation Tubing Adapters

- Adaptable to most insufflators for tubing standardization
- Not made with natural rubber latex
- Reusable, non-sterile

Product #	Description	Qty
28-0202	Plastic Quick Adapter, fits Circon®, Olympus®, Smith & Nephew, Dyonics®, and Snowden-Pencer® Tubing	1/Ea
28-0223	Stryker® Adapter	1/Ea
28-0224	Linvatec® Adapter	1/Ea
28-0225	Richard Wolf™ Adapter	1/Ea
28-0226	Karl Storz™ Adapter	1/Ea



Plastic Quick Adapter



Stryker® Adapter



Linvatec® Adapter



Richard Wolf™ Adapter



Karl Storz™ Adapter



### Insufflation Filter

- For use with reusable tubing
- Bi-directional .1 micron filter reduces the chance of contamination
- Not made with natural rubber latex
- Sterile

Product #	Description	Qty
28-0203	Sterile Disposable Insufflation Filter	20/Cs



### Veress Needles

- Spring-activated indicator identifies access to cavity
- Secure, on/off stopcock with insufflation luer-lock port
- Slim design for easy and smooth insertion
- Rounded, non-rotating obturator, 14 gauge with extra sharp needle
- Not made with natural rubber latex
- Sterile

Product #	Description	Qty
28-0601	120 mm	40/Cs
28-0602	150 mm	40/Cs
28-0611	120 mm	10/Cs
28-0612	150 mm	10/Cs



### Grab Bag™ Endoscopic Specimen Retrieval Pouch

- Durable polyurethane pouch is large enough to accommodate a wide range of specimens
- Unique “memory ring” automatically opens once inside abdomen
- Easy to use economic design
- Not made with natural rubber latex
- Sterile

Product #	Description	Qty
28-0001	Grab Bag™ Retrieval Pouch	10/Cs



### Kittner Laparoscopic Dissection Sponge



- Physician designed with tapered edges allow for easy insertion and removal
- X-ray detectable and passable through trocars 10 mm or larger
- High quality rayon fibers prevent disintegration and linting
- Not made with natural rubber latex
- Sterile

Product #	Description	Qty
30-305K	½" x 6"	5/Pk, 10 Pks/Cs

### Laparoscopic Instrument Pouch



- Secure, convenient storage of instruments close to the surgical site
- Reduces hand-to-hand transfer
- Three pockets for multiple instruments
- Extra long sleeve ensures the safe retention of all standard minimally invasive instruments
- Two adhesive strips securely attach the instrument pouch to the patient drape
- Not made with natural rubber latex

Product #	Description	Qty
25-303	Sterile 18.5" x 9.5"	30/Cs
25-303NS	Non-Sterile 18.5" x 9.5"	30/Cs

### Laparoscopic Dissectors

- Three tip types: 5 mm Kittner, 10 mm Cherry, and 5 mm Blunt
- 100% cotton tip
- Secure attachment
- X-ray detectable
- Not made with natural rubber latex
- Sterile

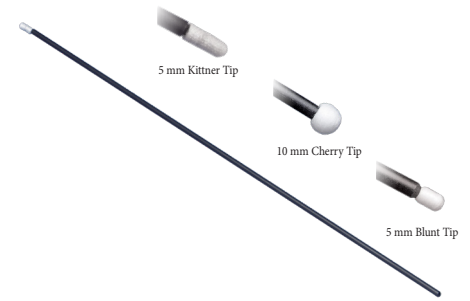

Product #	Description	Qty
28-0801	Kittner, 5 mm Tip, 45 cm shaft	10/Cs
28-0802	Cherry, 10 mm Tip, 41 cm shaft	10/Cs
28-0804	Blunt, 5 mm Tip, 41 cm shaft	10/Cs
28-BTD05	Tri-Pack Blunt, 5 mm Tip, 41 cm shaft	12/Cs

### TroClean™ Trocar Cleaning Device

- Absorbs fluid and removes debris from the inside barrel of a trocar
- Cleans without leaving smudges, biomass, or particulate
- Helps restore visibility quickly
- For use with trocar sizes 5 - 8 mm and 10 - 12 mm
- Pack contains 5 - 8 mm and 10 - 12 mm TroClean™ devices
- Sterile, single use device

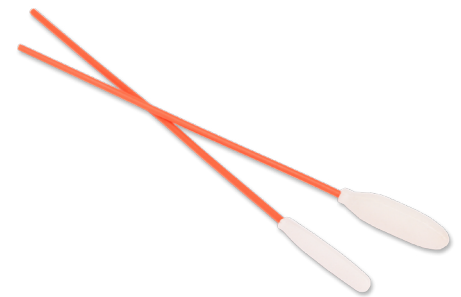

Product #	Description	Qty
28-1002	TroClean™ Trocar Cleaning Device	25/Cs

### SutureClose™ Laparoscopic Port Closure System

- Technology for fascia/peritoneum closure
- Ability to close multiple sites during same procedure
- Closure under laparoscopic visualization
- Mitigates the possibility of port site hernias
- Closure without having to extend the incision
- One-handed operation
- Single-use device
- Sterile



Product #	Description	Qty
28-1001	Laparoscopic Closure Needle and Guide	10/Cs

# Endoscopic and Laparoscopic

## Laparoscopic



### DeFogger™ Anti-Fog Solution

- Specially formulated solution that safely prevents lens fogging
- Will not damage scope
- Each bottle comes with non-abrasive, X-ray detectable foam pad
- Place a few drops on pad for fog-free surgery
- Adhesive-backed pad allows universal placement
- Contains 6 gm
- Not made with natural rubber latex
- Sterile

Product #	Description	Qty
28-0101	Oval Bottle	20/Cs
28-0101B	Oval Bottle, Bulk	750/Cs
28-0102	FlipTop	20/Cs
28-0102B	FlipTop, Bulk	750/Cs

### Scope Warmer



- Accommodates da Vinci® Robotic Scopes
- Easy-to-use design with dual sides offering twice the amount of warming time compared to most competitors
- Warms multiple endoscopes; including the scopes for saphenous vein harvesting
- Disposable and environmentally friendly
- Not made with DEHP
- Not made with natural rubber latex
- Sterile

Product #	Description	Qty
TM500D	Scope Warmer	10/Cs



### Laparoscopic Kits

- Packaged together for your convenience
- Can be customized to your preferences
- Not made with natural rubber latex
- Sterile

Product #	Description	Qty
28-0701	DeFogger™ Solution & Insufflation Tubing	10/Cs
28-0704	DeFogger™ Solution, Insufflation Tubing & Pneumo Needle	10/Cs

## Camera and Laser Arm Drape

- Easy-to-use telescopic fold with cuff
- Clear, elasticized fenestration for secure fit around endoscope
- Optional adhesive tape strip and rubber bands to further secure drape closure
- Stretchable neck material ensures tight fit
- Not made with natural rubber latex
- Sterile



Product #	Description	Qty
28-0401	7" x 96" Camera Drape, Laser Arm w/ Elastic Krayton Tip, ¼" Opening	60/Cs
28-0402	5" x 96" Camera Drape, Laser Arm w/ Perforated Tip, 2" Opening	20/Cs

## ProShield™ Protector & Contaminant Shield for Endoscopes

- Reduces risk of costly endoscope transport damage
- Funnel-style opening for quick and effortless insertion of scope, perfect for secured transport of scope
- Individually sealed to keep inside of ProShield™ clean, preventing microorganism-carrying dust from settling on or in tube surfaces
- Peel-pack seal for quick removal and use during stat-rushed conditions
- Sealed bottom contains contaminants and allows use of a rinsing solution to quickly remove materials before they harden and dry
- Enhanced and improved patient and staff safety
- Easy scope storage
- Enables immediate enzyme soap soaking of scope at patient bedside
- Helps reduce hospital-acquired infections
- Option for TEE Scopes
- Not made with natural rubber latex
- Sterile



9600-BU10D



9600-BP10D



9600-SD06D



9600-CW03D

### ProShield™ Protector and Containment Shield

Product #	Description	Qty
9600-030A-10D	Sealed Bottom, 30"	10/Cs
9600-030A-50D	Sealed Bottom, 30"	50/Cs
9600-036A-10D	Sealed Bottom, 36"	10/Cs
9600-036A-50D	Sealed Bottom, 36"	50/Cs
9600-048A-10D	Sealed Bottom TEE, 48"	10/Cs
9600-048A-50D	Sealed Bottom TEE, 48"	50/Cs

### ProShield™ Hardware

Product #	Description	Qty
9600-BU10D	Universal C-Bracket	1/Ea
9600-BP10D	IV Pole Mount	1/Ea
9600-SD06D	Table Top Stand	1/Ea
9600-CW03D	Cabinet	1/Ea

# Specialty Sponges

## Miscellaneous Sponges



### Nasal Sponges

- Provides gentle, even support for patient comfort
- Absorbs post-operative drainage following nasal surgery, ethmoidectomy procedures, or other endoscopic sinus surgeries
- Fiber free to reduce risk of adhesions or active rebleeding upon removal
- Quickly expands to control and absorb post-nasal discharge
- Optional airway tube improves patient breathing and comfort
- Not made with natural rubber latex
- Sterile

Product #	Description	Qty
34-101	Small Standard w/ String, 4.5 cm long x 1.5 cm thick x 2 cm high	1/Pk, 10 Pks/Cs
34-102	Large Standard w/ String, 8 cm long x 1.5 cm thick x 2 cm high	1/Pk, 10 Pks/Cs
34-103	Small Standard w/ Airway, 4.5 cm long x 1.5 cm thick x 2 cm high	1/Pk, 10 Pks/Cs
34-104	Large Standard w/ Airway, 8 cm long x 1.5 cm thick x 3 cm high	1/Pk, 10 Pks/Cs
34-105	Anatomical w/ String, 8 cm long x 1.5 cm thick x 3 cm high	1/Pk, 10 Pks/Cs
34-106	Anatomical w/ Airway & String, 8 cm long x 1.5 cm thick x 3 cm high	1/Pk, 10 Pks/Cs
34-107	Slim Anatomical w/ String, 8 cm long x 0.75 cm thick x 3 cm high	1/Pk, 10 Pks/Cs



### Epistaxis Sponges

- Provides quick and effective control of nasal bleeding
- Atraumatic removal helps prevent active rebleeding
- Compressed configuration slides easily into nasal cavity
- Quickly expands to absorb fluids while maintaining patient comfort
- Not made with natural rubber latex
- Sterile

Product #	Description	Qty
34-201	Large w/ String 10 cm long x 1.5 cm thick x 2.5 cm high	1/Pk, 10 Pks/Cs
34-202	Small w/ String 5.5 cm long x 1.5 cm thick x 2.5 cm high	1/Pk, 10 Pks/Cs

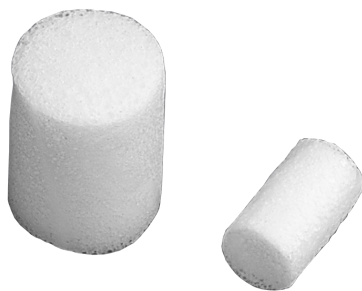

### Otology Sponges

- Reduces risk of stenosis of the external ear canal following otic surgery
- Compressed configuration allows easy insertion into the ear canal
- Keeps antibiotics in contact with the wound site through anatomical expansion
- Fiber free to minimize tissue ingrowth
- Not made with natural rubber latex
- Sterile

Product #	Description	Qty
34-401	Otitis External Wick, 9 mm x 15 mm	1/Pk, 10 Pks/Cs
34-402	Otitis External Wick, 9 mm x 24 mm	1/Pk, 10 Pks/Cs

### Lint-Free Ophthalmic Sponges

- Allows the ophthalmologist to perform lint-free fluid control
- Extremely soft and fast-wicking
- Not made with natural rubber latex
- Sterile

Product #	Description
34-501	Corneal Shield, 7 mm diameter
34-506*	Wick & Wipe Instrument Wipe w/ Wick

Qty
1/Pk, 10 Pks/Cs
1/Pk, 10 Pks/Cs

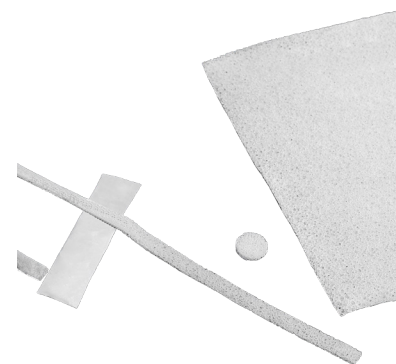

\* Available in Non-Sterile- add NS to Product Number

### Eye Spear/Fine Dissector

- X-Ray detectable
- Fine-pore, cellulose fiber is low-linting and absorbent
- Not made with natural rubber latex
- Sterile

Product #	Description
30-049*	Eye Spear/Fine Dissector
30-049-6	Eye Spear/Fine Dissector
30-049-10	Eye Spear/Fine Dissector

Qty
10/Pk, 10 Pks/Cs
6/Pk, 50 Pks/Cs
10/Pk, 50 Pks/Cs



\* Available in Non-Sterile- add NS to Product Number

### PVA Eye Spear

- Designed to be used in Lasik surgery and cataract surgery
- Constructed of virtually lint-free polyvinyl acetal to reduce eye irritation
- Absorbs up to five times more fluid than standard cellulose spears
- Expands instantly when in contact with fluids
- Allows for gentle manipulation of delicate tissues
- High tensile strength without breaking apart
- Sterile

Product #	Description
30-049-P5	PVA Eye Spears

Qty
5/Pk, 40 Pks/Cs





# Specialty Sponges

## Dissecting Sponges



### Rosebud Dissector

- Smaller and firmer than a Peanut or Round dissector
- X-ray detectable radiopaque element
- Foam holder enables easy sponge count
- Not made with natural rubber latex
- Sterile

Product #	Description	Qty
30-202	1/4" in Foam Holder	5/Pk, 40 Pks/Cs



### Peanut Sponge

- X-ray detectable radiopaque element
- Foam holder enables easy sponge count
- Not made with natural rubber latex
- Sterile

Product #	Description	Qty
30-106*	3/8" in Foam Holder	5/Pk, 50 Pks/Cs
30-010	Double Strung	5/Pk, 100 Pks/Cs

\* Available in Non-Sterile- add NS to Product Number



### Cherry Sponge

- Largest of the dissectors
- X-ray detectable radiopaque element
- Foam holder enables easy sponge count
- Not made with natural rubber latex
- Sterile

Product #	Description	Qty
30-112*	1/2" in Foam Holder	5/Pk, 50 Pks/Cs

\* Available in Non-Sterile- add NS to Product Number

### Round (Hard) Dissector

- X-ray detectable radiopaque element
- Foam holder enables easy sponge count
- Not made with natural rubber latex
- Sterile

Product #	Description	Qty
30-115*	3/8" Foam Holder	5/Pk, 50 Pks/Cs

\* Available in Non-Sterile- add NS to Product Number

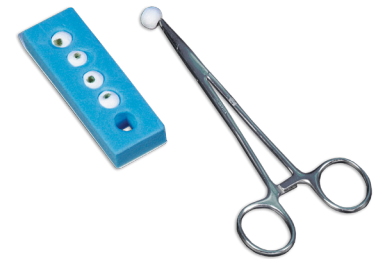

### Kittner (Blunt) Dissector

- Can be used as a longitudinal or folded sponge for dissection
- Constructed of high-quality cotton twill
- X-ray detectable radiopaque element
- Foam holder enables easy sponge count
- Not made with natural rubber latex
- Sterile

Product #	Description	Qty
30-101*	9/16" x 1/4" Foam Holder	5/Pk, 50 Pks/Cs

\* Available in Non-Sterile- add NS to Product Number



# Specialty Sponges

## Tonsil & Adenoid Sponges



### Single-Strung Tonsil Sponges

- Covered with gauze and cotton filled for maximum absorbency
- X-ray detectable radiopaque element
- Constructed with a 15", white, memory-free cotton string
- Not made with natural rubber latex
- Sterile

Product #	Description	Qty
30-036*	Small ¾"	5/Pk, 100 Pks/Cs
30-037*	Medium 7/8"	5/Pk, 100 Pks/Cs
30-038*	Large 1"	5/Pk, 100 Pks/Cs
30-039*	X-Large 1¼"	5/Pk, 100 Pks/Cs

\* Available in Non-Sterile- add NS to Product Number



### Double-Strung Tonsil Sponges

- Covered with gauze and cotton filled for maximum absorbency
- X-ray detectable radiopaque element
- Constructed with a No. 3 blue thread for ease of retrieval
- Not made with natural rubber latex
- Sterile

Product #	Description	Qty
30-040*	Small ¾"	5/Pk, 100 Pks/Cs
30-041*	Medium 7/8"	5/Pk, 100 Pks/Cs
30-042*	Large 1"	5/Pk, 100 Pks/Cs
30-043*	X-Large 1¼"	5/Pk, 100 Pks/Cs

\* Available in Non-Sterile- add NS to Product Number



### Round Adenoid Sponge

- X-ray detectable radiopaque element
- Not made with natural rubber latex
- Sterile

Product #	Description	Qty
30-044	Standard 1½"	5/Pk, 50 Pks/Cs

### Flat Stick Sponges

- May be used with a foerster clamp
- Designed for absorption
- X-ray detectable radiopaque element
- Not made with natural rubber latex
- Sterile



Product #	Description	Qty
30-022*	1½"	10/Pk, 50 Pks/Cs
30-222*	2"	10/Pk, 50 Pks/Cs

\* Available in Non-Sterile- add NS to Product Number

### Round Stick Sponges

- Designed for absorption
- X-ray detectable radiopaque element
- Not made with natural rubber latex
- Sterile



Product #	Description	Qty
30-026*	Small ¾"	10/Pk, 50 Pks/Cs
30-025*	Medium 1"	10/Pk, 50 Pks/Cs
31-807	Large 1¼"	3/Pk, 50 Pks/Cs
30-122	X-Large 1½"	5/Pk, 50 Pks/Cs
30-024*	X-Large 1½"	10/Pk, 50 Pks/Cs

\* Available in Non-Sterile- add NS to Product Number

### Triangle Sponge

- May be easily rolled or folded for dissection or used as a prepping sponge
- X-ray detectable radiopaque element
- Not made with natural rubber latex
- Sterile



Product #	Description	Qty
30-018	Medium 2" x 1"	10/Pk, 50 Pks/Cs

# Specialty Sponges

## Sterile Cotton Balls



### Sterile Cotton Balls

- Designed for prepping, wound cleaning, and perineal care
- Not made with natural rubber latex
- Sterile

Product #	Description	Qty
31-090	Medium 1"	10/Pk, 100 Pks/Cs
30-030	Large 1¼"	5/Pk, 100 Pks/Cs



### Double-Strung Cotton Balls

- Constructed with a 15" blue silk thread for ease of retrieval
- X-ray detectable radiopaque element
- Not made with natural rubber latex
- Sterile

Product #	Description	Qty
30-031	Tiny ¼"	5/Pk, 50 Pks/Cs
30-176	X-Small ⅜"	5/Pk, 50 Pks/Cs
30-032	Small ½"	5/Pk, 50 Pks/Cs
30-033	Medium ¾"	5/Pk, 50 Pks/Cs
30-034	Large 1"	5/Pk, 50 Pks/Cs
30-035	X-Large 1¼"	5/Pk, 50 Pks/Cs

### Double-Strung Cylindrical Sponges

- X-ray detectable radiopaque element
- Not made with natural rubber latex
- Sterile

Product #	Description	Qty
30-045*	1½" x ½"	5/Pk, 100 Pks/Cs

\* Available in Non-Sterile- add NS to Product Number



### Dental Rolls

- Designed to keep the area dry, absorbing saliva and moisture
- Available in regular and quilted
- Not made with natural rubber latex
- Sterile

Product #	Description	Qty
30-096	Regular 1½" x ¾"	5/Pk, 100 Pks/Cs
30-419	Regular 3" x ¾"	4/Pk, 100 Pks/Cs
31-207	Quilted 1½" x ¾"	5/Pk, 25 Pks/Cs



### Ear Wicks (Cellulose)

- Non-traumatic and virtually lint-free
- Compressed and die-cut of absorbent fine-pore cellulose fiber
- Not made with natural rubber latex
- Sterile

Product #	Description	Qty
30-048	⅛" x ¼"	5/Pk, 20 Pks/Cs

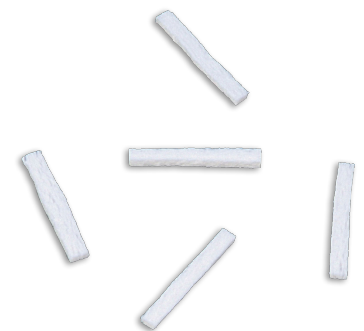

### Tracheotomy Sponge

- Made of absorbent, 4" x 4", 12-ply gauze sponge
- Ideal around any drainage area to protect from chafing
- Not made with natural rubber latex
- Sterile

Product #	Description	Qty
30-051	4" x 4"	25/Pk, 12 Pks/Cs
30-052	4" x 4"	25/Pk, 20 Pks/Cs



# Specialty Sponges

## Neurology Sponges

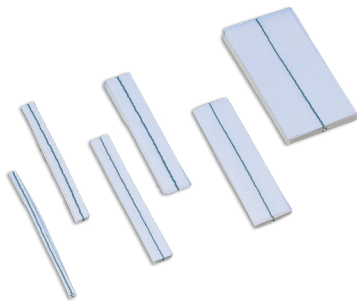

## Neuro Sponges in Patties & Strips

- High-quality rayon fibers prevent disintegration and linting, reducing the risk of granulomas
- Pliable when wet, allowing patties and strips to conform to irregular contours
- X-Ray detectable element
- Locator string attached to the patties increases visibility and assists in identification
- Patties come with counting card in each pack
- Not made with natural rubber latex
- Sterile

### Patties

Product #	Description	Qty
30-054*	½" x ½"	10/Pk, 20 Pks/Cs
30-055*	½" x 1"	10/Pk, 20 Pks/Cs
30-056*	½" x 1½"	10/Pk, 20 Pks/Cs
30-057*	½" x 3"	10/Pk, 20 Pks/Cs
30-058*	¾" x ¾"	10/Pk, 20 Pks/Cs
30-059*	1" x 1"	10/Pk, 20 Pks/Cs
30-060*	1" x 3"	10/Pk, 20 Pks/Cs
30-061*	1½" x 1½"	10/Pk, 20 Pks/Cs
30-063*	3" x 3"	10/Pk, 20 Pks/Cs
30-067*	¼" x 1½"	10/Pk, 20 Pks/Cs
30-068*	½" x 2"	10/Pk, 20 Pks/Cs
30-069*	¼" x 3"	10/Pk, 20 Pks/Cs
30-072*	¾" x 3"	10/Pk, 20 Pks/Cs
30-154*	¼" x ¼"	10/Pk, 20 Pks/Cs

\* Products available in Non-Sterile- add NS to Product Number

### Strips

Product #	Description	Qty
30-300*	¼" x 6"	10/Pk, 20 Pks/Cs
30-301*	½" x 6"	10/Pk, 20 Pks/Cs
30-302*	1" x 6"	10/Pk, 20 Pks/Cs
30-303*	¾" x 6"	10/Pk, 20 Pks/Cs
30-304*	1½" x 6"	10/Pk, 20 Pks/Cs
30-305*	3" x 6"	10/Pk, 20 Pks/Cs
30-306*	2" x 6"	10/Pk, 20 Pks/Cs
30-307*	3½" x 6"	10/Pk, 20 Pks/Cs

\* Products available in Non-Sterile- add NS to Product Number



### Cotton Lap Sponges

- Consists of 100% cotton
- X-ray detectable
- Pre-washed consisting of 24/20 gauze
- Wrapped and placed in peel pouch for easy sterile presentation
- Not made with natural rubber latex
- Sterile



Product #	Description	Qty
1-418*	4" x 18" Pre-washed, w/o Rings	5/Pk, 20 Pks/Cs
1-836	8" x 36" Pre-washed, w/o Rings	5/Pk, 20 Pks/Cs
1-8108	8" x 108" Pre-washed, w/o Rings	5/Pk, 20 Pks/Cs
1-1818*	18" x 18" Pre-washed, w/o Rings	5/Pk, 20 Pks/Cs
1-1836-5	18" x 36" Pre-washed, w/o Rings	5/Pk, 20 Pks/Cs

\* Available in Non-Sterile- add NS to Product Number

### Lap Sponges

- Pre-washed consisting of 24/20 gauze
- Economically priced for a variety of uses
- Consists of 100% cotton
- X-ray detectable
- Not made with natural rubber latex
- Sterile



Product #	Description	Qty
9-1818	18" x 18" Pre-washed, w/o Rings	5/Pk, 20 Pks/Cs
200-1818*	18" x 18" Pre-washed, w/o Rings	5/Pk, 40 Pks/Cs
200-1818R	18" x 18" Pre-washed, w/ Rings	5/Pk, 40 Pks/Cs
9-1212	12" x 12" Pre-washed, w/o Rings	5/Pk, 20 Pks/Cs
200-1212*	12" x 12" Pre-washed, w/o Rings	5/Pk, 40 Pks/Cs
9-418	4" x 18" Pre-washed, w/o Rings	5/Pk, 20 Pks/Cs
200-418	4" x 18" Pre-washed, w/o Rings	5/Pk, 40 Pks/Cs
200-418R	4" x 18" Pre-washed, w/ Rings	5/Pk, 40 Pks/Cs

\* Products available in Non-Sterile- add NS to Product Number

# Specialty Sponges

## Packing

### Vaginal & Perineal Packing

- Pre-washed, 4-ply gauze
- Vaginal packing complete with X-ray detectable radiopaque element
- Folded and packaged in peel pouch
- Not made with natural rubber latex
- Sterile



Product #	Description	Qty
1-136	Vaginal Packing, w/ X-ray Element, 1" x 36"	1/Pk, 100 Pks/Cs
1-237	Vaginal Packing, w/ X-ray Element, 2" x 36"	1/Pk, 50 Pks/Cs
1-272	Vaginal Packing, w/ X-ray Element, 2" x 72"	1/Pk, 50 Pks/Cs
1-424	Vaginal Packing, w/ X-ray Element, 4" x 96"	1/Pk, 20 Pks/Cs
1-472	Vaginal Packing, w/ X-ray Element, 4" x 72"	1/Pk, 100 Pks/Cs
1-436	Vaginal Packing, w/ X-ray Element, 4" x 36"	1/Pk, 100 Pks/Cs
1-250	Perineal Packing, w/o X-ray Element, 2" x 180"	1/Pk, 50 Pks/Cs
1-230	Perineal Packing, w/o X-ray Element, 2" x 108"	1/Pk, 50 Pks/Cs
1-150	Perineal Packing, w/o X-ray Element, 1" x 180"	1/Pk, 25 Pks/Cs

### Sponge Counter Bag

- Allows continuous sponge counting and containment to minimize exposure to bloodborne pathogens
- Easy open pockets for simple disposal of used sponges
- Accommodates five laparotomy sponges or ten 4" x 4"s
- Clear polyethylene pockets allow sponges to be viewed for visual estimate of patient blood loss
- Additional bags can be placed over filled ones as necessary
- Not made with natural rubber latex
- Non-sterile

Product #	Description	Qty
25-500	Clear Back	50 Bgs/Crtn, 5 Crtns/Cs
25-551	Blue Back w/ Adhesive Seal	50 Bgs/Crtn, 5 Crtns/Cs
25-501	Mounting Bracket	1/Ea



# Surgical Accessories

## Operating Room Towels

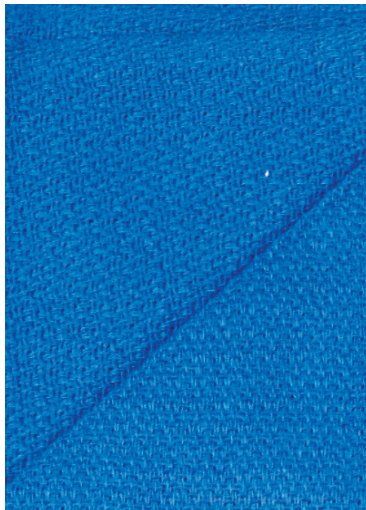

### OR Towels

- 26" x 16"
- Pre-washed
- Low linting
- Manufactured in Mexico, a USMCA country
- Not made with natural rubber latex
- Sterile

Product #	Description	Qty
60-102	Blue	1/Pk, 80 Pks/Cs
60-106	Blue	2/Pk, 40 Pks/Cs
60-101	Blue	4/Pk, 20 Pks/Cs
60-103	Blue	6/Pk, 12 Pks/Cs

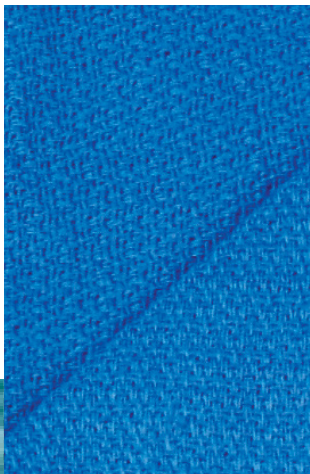

### Standard OR Towels

- High-quality "huck" towels
- Pre-washed, de-linted
- 27" x 17"
- 58/25 mesh
- 65 grams by weight
- Color will not bleed
- 100% cotton
- Not made with natural rubber latex
- Sterile

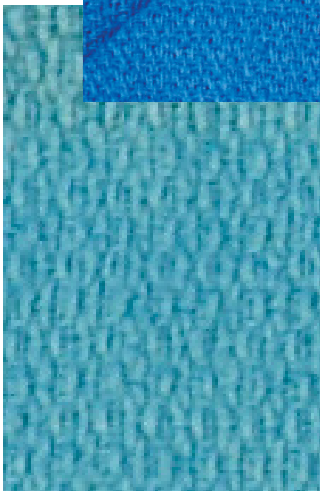

Product #	Description	Qty
63-102	Blue	1/Pk, 80 Pks/Cs
63-106	Blue	2/Pk, 40 Pks/Cs
63-101	Blue	4/Pk, 20 Pks/Cs
63-108	Blue	5/Pk, 16 Pks/Cs
63-103	Blue	6/Pk, 12 Pks/Cs
63-100	Blue	8/Pk, 10 Pks/Cs
63-110	Blue	30/Pk, 2 Pks/Cs
63-206	Green	2/Pk, 40 Pks/Cs
63-201	Green	4/Pk, 20 Pks/Cs
63-203	Green	6/Pk, 12 Pks/Cs
63-200	Green	8/Pk, 10 Pks/Cs
63-207	Green	10/Pk, 8 Pks/Cs

### OR Safety Towels

- Preferred for wound packing by nurses
- X-ray detectable radiopaque element
- Pre-washed
- Low-linting
- Manufactured in Mexico, a USMCA country
- Not made with natural rubber latex
- Sterile

Product #	Description	Qty
68-106	Blue	2/Pk, 40 Pks/Cs
68-108	Blue	5/Pk, 16 Pks/Cs
68-103	Blue	6/Pk, 12 Pks/Cs
68-402	White	1/Pk, 80 Pks/Cs
68-406	White	2/Pk, 40 Pks/Cs
68-401	White	4/Pk, 20 Pks/Cs
68-408	White	5/Pk, 16 Pks/Cs



### Fenestrated Towels

- High-quality “huck” towels
- Pre-washed and de-linted
- 26” x 17”
- 58/25 mesh
- 65 grams by weight
- Color will not bleed
- 100% cotton
- Not made with natural rubber latex
- Sterile

Product #	Description	Qty
70-150	White, 1½” Fenestration	1/Pk, 20 Pks/Cs
32-082	Blue, 2½” Fenestration	1/Pk, 50 Pks/Cs
70-103	White, 3” Fenestration	1/Pk, 20 Pks/Cs
32-998	Blue, 30” x 34” w/ 5” x 10” Fenestration	1/Pk, 40 Pks/Cs

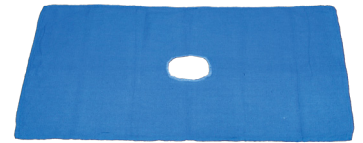

# Surgical Accessories

## Vessel Loops

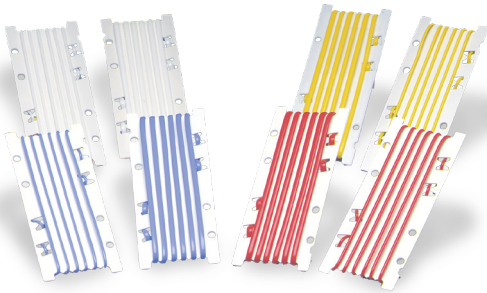

## Vessel Loops

- High quality medical-grade silicone
- Strong and durable, yet gentle
- Non-porous to slide smoothly and easily over vessels
- Radiopaque element ensures X-ray detectability
- Color-coded to assist in vessel detection
- Dispenser boxes minimize storage space required
- Two 18" strands included in each pack
- Two sizes available:
  - Minis: 1.3 mm wide and 0.9 mm thick
  - Maxis: 2.5 mm wide and 1.0 mm thick
- Wrapped on a plastic card for tangle-free presentation and placement in sterile field
- Not made with natural rubber latex
- Sterile

Product #	Description	Qty
30-711	White Mini, 2/Card	2/Pk, 25 Pks/Bx, 2 Bx/Cs
30-712	Red Mini, 2/Card	2/Pk, 25 Pks/Bx, 2 Bx/Cs
30-713	Blue Mini, 2/Card	2/Pk, 25 Pks/Bx, 2 Bx/Cs
30-714	Yellow Mini, 2/Card	2/Pk, 25 Pks/Bx, 2 Bx/Cs
30-721	White Maxi, 2/Card	2/Pk, 25 Pks/Bx, 2 Bx/Cs
30-722	Red Maxi, 2/Card	2/Pk, 25 Pks/Bx, 2 Bx/Cs
30-723	Blue Maxi, 2/Card	2/Pk, 25 Pks/Bx, 2 Bx/Cs
30-724	Yellow Maxi, 2/Card	2/Pk, 25 Pks/Bx, 2 Bx/Cs
30-731	White Mini, 2/Card	2/Pk, 10 Pks/Bx, 1 Bx/Cs
30-732	Red Mini, 2/Card	2/Pk, 10 Pks/Bx, 1 Bx/Cs
30-733	Blue Mini, 2/Card	2/Pk, 10 Pks/Bx, 1 Bx/Cs
30-734	Yellow Mini, 2/Card	2/Pk, 10 Pks/Bx, 1 Bx/Cs
30-741	White Maxi, 2/Card	2/Pk, 10 Pks/Bx, 1 Bx/Cs
30-742	Red Maxi, 2/Card	2/Pk, 10 Pks/Bx, 1 Bx/Cs
30-743	Blue Maxi, 2/Card	2/Pk, 10 Pks/Bx, 1 Bx/Cs
30-744	Yellow Maxi, 2/Card	2/Pk, 10 Pks/Bx, 1 Bx/Cs



### SurgiClick® Flexible Light Handle Covers

- Patented design snaps firmly and easily into place to minimize contamination risks
- Unique ergonomic design minimizes risk of splitting or tearing of plastic while ensuring a no-slip grip
- Rigid flange allows quick, easy application
- Reduces the cost of processing, sterilizing, and storing light handles
- Flat packaging for efficient storage
- Light handle adapters are available to fit most brands of surgical lights
- Sterile



Product #	Qty
26-011	1/Pk, 60 Pks/Bx, 2 Bxs/Cs
26-012	2/Pk, 30 Pks/Bx, 2 Bxs/Cs
26-013	3/Pk, 25 Pks/Bx, 2 Bxs/Cs

### Saf-T-Glove™ Flexible Light Handle Covers

- Double angle flange for easier application
- Serpentine rib design for reinforcement of flange
- Light handle adapters are available to fit most brands of surgical lights
- Friction-fit provides a secure fit to minimize risk of contamination
- Sterile



Product #	Qty
AM3611	1/Pk, 50 Pks/Bx, 2 Bxs/Cs
AM3612	2/Pk, 50 Pks/Bx, 2 Bxs/Cs
AM3613	3/Pk, 50 Pks/Bx, 2 Bxs/Cs

### Rigid Light Handles

- Rigid flange allows quick aseptic application
- Screw-on design is safe and secure
- Textured handles ensure no-slip grip
- Unique interlocking design eliminates need to package using latex-containing rubber bands or paper bands
- Special packaging configuration facilitates sterile presentation minimizing the risks of contaminating the sterile field
- Light handle adapters are available to fit most brands of surgical lights
- Not made with natural rubber latex
- Sterile



Product No.	Qty
26-021	1/Pk, 12 Pks/Bx, 4 Bxs/Cs
26-022	2/Pk, 12 Pks/Bx, 2 Bxs/Cs
26-022B	2/Pk, 72 Pks/Cs
26-023	3/Pk, 8 Pks/Bx, 2 Bxs/Cs

\* Note: Light Handle Adaptors Available





# Surgical Accessories

## Skin Staplers



### Premium Fixed Head Skin Stapler

- Fixed Head Stapler has clear viewing window for maximum visibility and 35-staple count
- All staplers have “pre-cocking” capacity for precision placement
- High quality, 316L stainless steel staples
- DeRoyal® Staples:
  - Maximize sharpness to reduce tissue trauma
  - Wider tissue draw
  - Taller for deeper tissue hold
- Not made with natural rubber latex
- Sterile

Product #
25-3001*
25-3001C
25-3002*

Description
35-Count, Wide
Economy 35-Count, Wide
35-Count, Regular

Staple Dimension After Closure
4.7 mm H x 6.5 mm W
4.7 mm H x 6.5 mm W
3.7 mm H x 5.7 mm W

Qty
6 Pks/Bx, 4 Bxs/Cs
6 Pks/Bx, 4 Bxs/Cs
6 Pks/Bx, 4 Bxs/Cs



### Deluxe Fixed Head Skin Stapler

- Contains a counter with no reversible function
- Open staple measures 11.8 mm x 3.4 mm
- Closed staple measures 6.8 mm x 4.0 mm
- Surgical-grade stainless steel staples
- Ergonomic handle design
- Open-ended for visibility and ease of placement and positioning
- Gear-down mechanism to slow staple formation and minimize tearing during skin puncture
- Audible click to indicate staple is fully formed
- Soft and even trigger pull
- Easy-grasp packaging facilitates sterile presentation
- Not made with natural rubber latex
- Sterile

Product #	Description	Qty
25-3003	Deluxe 35 Count, Wide	30/Cs



### Skin Staple Extractor

- For safe, easy removal of skin staples after wound healing
- Packaged sterile with all items needed for convenient aseptic staple removal, including alcohol prep pad and 2" x 2" gauze
- Not made with natural rubber latex
- Sterile

Product #	Description	Qty
TSR-1	Skin Staple Remover	12 Pks/Bx, 2 Bxs/Cs

**⚠️ \*WARNING-** This product can expose you to chemicals including Titanium Dioxide, which is known to the State or California to cause cancer. For more information, go to [www.P65Warnings.ca.gov](http://www.P65Warnings.ca.gov).

### Pre-Op Mini Marker

- Mini marker satisfies Joint Commission criteria for prevention of wrong site/wrong surgery
- Less waste than full size skin marker
- Reduces opportunity for cross contamination by lessening the temptation to reuse
- Comfortable thickness and length for ease of use
- Convenient storage
- Non-toxic and non-tattooing
- Not made with natural rubber latex
- Non-sterile



Standard Ink	Description	Qty
26-017NS*	Pre-Op Skin Marker	800/Cs
26-018NS*	Pre-Op Skin Marker	200/Cs

Prep-Resistant Ink	Description	Qty
26-018PRNS*	Pre-Op Skin Marker	200/Cs

### Dual-Tip Skin Markers

- Ideal solution for writing medication labels and marking skin on the sterile field
- Supports Joint Commission compliance for labeling medications/solutions on the sterile field
- Consolidates label marker and skin marker into one, for an economical waste reduction solution
- Not made with natural rubber latex



Product #	Description	Qty
26-019*	Regular & Ultra Fine Tip	50/Cs
26-019NS*	Regular & Ultra Fine Tip, Non-sterile	200/Cs
26-020*	Regular & Ultra Fine Tip w/ Ruler & Labels	50/Cs

 \*WARNING- This product can expose you to chemicals including Gentian Violet, which is known to the State of California to cause cancer. For more information, go to [www.P65Warnings.ca.gov](http://www.P65Warnings.ca.gov).

# Surgical Accessories

## Surgical/Utility Markers



## Skin Markers and Rulers

- For smooth, clear line markings on patient's skin
- Prep-resistant gentian violet ink
- Non-toxic and non-tattooing
- Each barrel legibly ruled in centimeters
- Flexible 15 cm ruler allows measurement of body curves
- Optional blank labels for identification of medications or specimens
- Individually packaged in sterile peel pouches for fiber-free introduction into sterile field
- Dispenser boxes minimize storage and maximize convenience
- Not made with natural rubber latex
- Sterile unless otherwise noted

Standard Ink	Description	Qty
26-001*	Standard Tip w/ Ruler (Blue Barrel)	50/Cs
26-002*	Fine Tip w/ Ruler (White Barrel)	50/Cs
26-003*	Standard Tip w/ Ruler & 8 Up Label (Blue Barrel)	50/Cs
26-004*	Fine Tip w/ Ruler & 8 Up Label (White Barrel)	50/Cs
26-005*	Standard Tip (Blue Barrel)	50/Cs
26-006*	Fine Tip (White Barrel)	50/Cs
32-345	Sterile 6" Ruler	30/Cs

Prep Resistant Ink	Description	Qty
26-001PR*	Standard Tip w/ Ruler	50/Cs
26-003PR*	Standard Tip w/ Ruler & 8 Up Label	50/Cs
26-005PR*	Standard Tip	50/Cs
26-005PRNS*	Standard Tip, Non-Sterile	100/Cs

 \*WARNING- This product can expose you to chemicals including Gentian Violet, which is known to the State of California to cause cancer. For more information, go to [www.P65Warnings.ca.gov](http://www.P65Warnings.ca.gov).

### Suture Boots

- Facilitates grasping and tagging without damage to delicate sutures
- Extended adhesive peel-off backing for secure placement and quick removal
- Available in two sizes for a perfect fit:
  - Standard - .062" inside diameter
  - Large - .093" inside diameter
- Radiopaque element ensures X-ray detectability
- Offered in a variety of colors
- Packaged for easy sterile presentation
- Not made with natural rubber latex

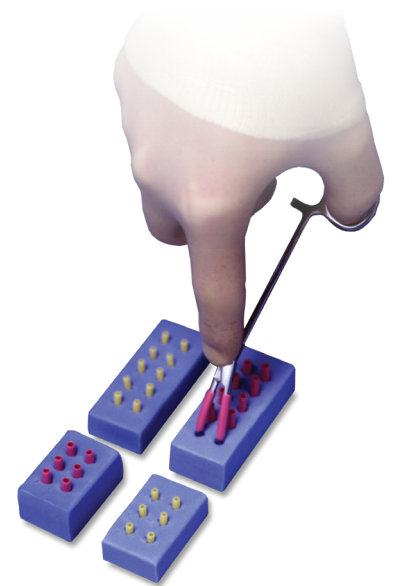

<b>Sterile</b>	<b>Non-Sterile</b>	<b>Description</b>	<b>Qty</b>
30-701*	30-701NS*	Standard Yellow	10/Pk, 50 Pks/Cs
30-702*	30-702NS*	Standard Yellow	6/Pk, 50 Pks/Cs
30-706*	—	Standard Yellow	10/Pk, 20 Pks/Cs
30-703±	30-703NS±	Large Pink	10/Pk, 25 Pks/Cs
—	30-704NS±	Large Pink	6/Pk, 25 Pks/Cs
30-705*	—	Standard Assorted	20 Pks/Cs

\*WARNING- This product can expose you to chemicals including di-isodecyl phthalate, which is known to the State of California to cause birth defects or other reproductive harm. For more information, go to [www.P65Warnings.ca.gov](http://www.P65Warnings.ca.gov).

†WARNING- This product can expose you to chemicals including diisononyl phthalate, which is known to the State of California to cause cancer, and di-isodecyl phthalate, which is known to the State of California to cause birth defects or other reproductive harm. For more information, go to [www.P65Warnings.ca.gov](http://www.P65Warnings.ca.gov).

# Surgical Accessories

## Instrument Pads, Pouches & Wipes

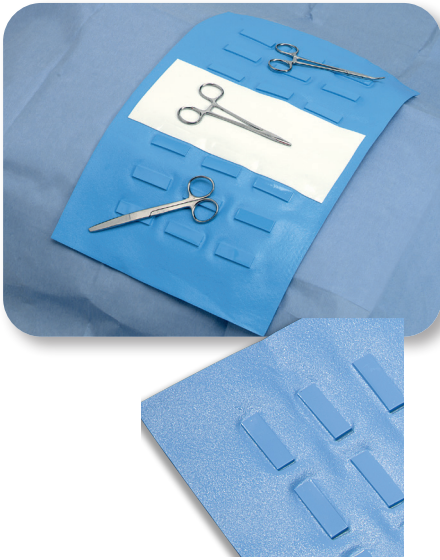

### Magnetic Instrument Pad

- Helps reduce accidental sharps injuries associated with instrument passing
- Available with or without white transfer zone for instrument placement
- Encourages hands-free passing of sharps as part of safety programs
- Not made with natural rubber latex
- Sterile

#### Without Transfer Zone

Product #	Description	Qty
25-001	10" x 16"	30 Pks/Cs
25-002	20" x 16"	20 Pks/Cs

#### With Transfer Zone

Product #	Description	Qty
25-003	10" x 16"	30 Pks/Cs
25-004	20" x 16"	20 Pks/Cs

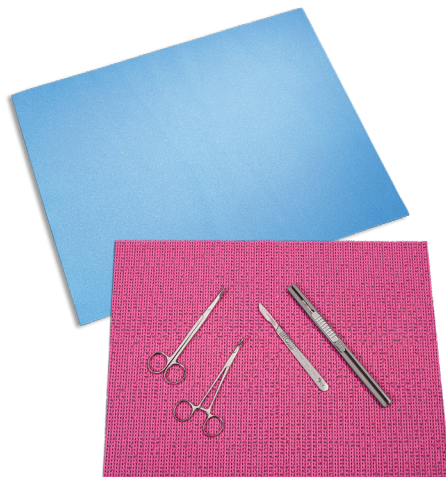

### Non-Magnetic Instrument Pad

- Provides sterile neutral field for the safe placement of instruments
- Instruments cling to special slip-proof surface
- Lies securely over drapes
- May be used to cover Mayo Stand to reduce noise
- May be rolled up on Mayo Stand for instrument positioning
- Not made with natural rubber latex
- Available in sterile and non-sterile

Product #	Description	Qty
25-011	Instrument Pad, 20" x 16"	30/Cs
25-012	Pink Instrument Pad, 12" x 16"	25/Cs
25-012NS	Non-Sterile Pink Instrument Pad, 12" x 16"	200/Cs

### Instrument Pouch

- Minimizes hand-to-hand transfer
- Secure, convenient storage of instruments close to surgical site
- Keeps frequently used instruments out of the way yet within surgeon's reach
- Three pockets for multiple instruments
- Extra long sleeve securely holds complete laparoscopic instrument
- Two surfaces of double-sided tape for secure placement
- Not made with natural rubber latex
- Sterile



Product #	Description	Qty
25-303	3-Pocket, 18.5" x 9.5"	30/Cs
25-302	2-Pocket, 11.5" x 7"	30/Cs

### Instrument Wipe

- For scratch-free cleaning of ophthalmic and other delicate instruments
- Non-linting
- Soft, sponge-like material (polyvinyl alcohol)
- Highly absorbent
- Not made with natural rubber latex

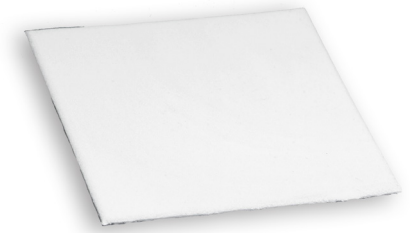

Product #	Description	Qty
25-201	Polyvinyl Alcohol 2½" x 2½"	120/Cs



# Surgical Accessories

## Holders & Clamps

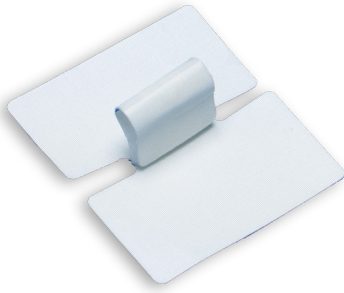

### For use with:

- Jejunostomy tubing
- Leg Bag tubing
- Subclavian port lines
- Wound drainage tubing
- Peritoneal dialysis exit site tubing
- A variety of other tubes and catheters

## Multi-Purpose Tube Holder

- Ideal for securing Foley Catheters and a variety of tubes and catheters
- Adhesive loop securely holds Foley Catheter in place and helps prevent tube dislodgment
- Designed for quick and easy placement of all sizes of tubing and lines
- Easy-to-apply adhesive base attaches firmly to skin, cloth, or drapes
- Gentle to skin and easily removed without painful pulling
- Holds lines securely in place, once line is positioned on patient
- Secure placement for positioning to create slack without bladder traction, thus decreasing risk of urinary tract infection
- Easy to position and reposition tabs
- Made with natural rubber latex
- Non-sterile

Product #	Description	Qty
30-1002*	Medium, Non-Sterile	50 Pks/Cs
30-1003*	Large, Non-Sterile	50 Pks/Cs



## Towel Clamp

- Positions drapes, towels, and sponges in sterile field
- Built-in wire holder for cautery pencil or other wires
- Special bridge in curved jaws clamp and occlude a variety of tubes
- Nylon reinforced plastic is strong and durable
- Not made with natural rubber latex

Product #	Description	Qty
30-901	Towel Clamp	1/Pk, 80 Pks/Cs
30-902	Towel Clamp	2/Pk, 120 Pks/Cs
30-900NS	Towel Clamp, Non-Sterile	100/Cs

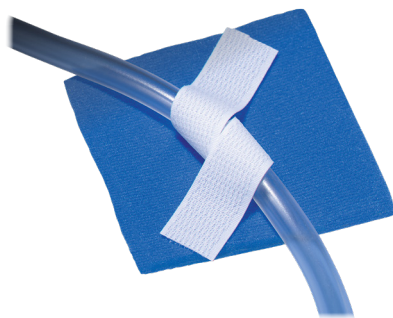

## Tube Positioner

- Allows stationary placement of tubes, lines, and cords in sterile field
- Extended adhesive peel-off backing for anchored placement
- Easily removed by gloved personnel
- Raypaque element ensures X-ray detectability
- Not made with natural rubber latex

Product #	Description	Qty
30-802*	Tube/Cord Holder	25 Pks/Bx, 2 Bxs/Cs

 \*WARNING- This product can expose you to chemicals including Ethylbenzene, which is known to the State or California to cause cancer, and Toluene, which is known to the State of California to cause birth defects or other reproductive harm. For more information, go to [www.P65Warnings.ca.gov](http://www.P65Warnings.ca.gov).



### Breathing Circuit Support Clamp

- Holds breathing circuits and suction tubes in place
- Relieves the “tug” on the ET (endotracheal tube) connection
- Reduces risk of kinks in ET tube, more comfortable for ICU patient
- Reduces chance of a disconnection
- Provides suction handle support
- Easy to use and holds tubing securely to patient’s gown, bedding, or drape
- Convenient support, easily positioned by staff
- Not made with natural rubber latex
- Non-sterile

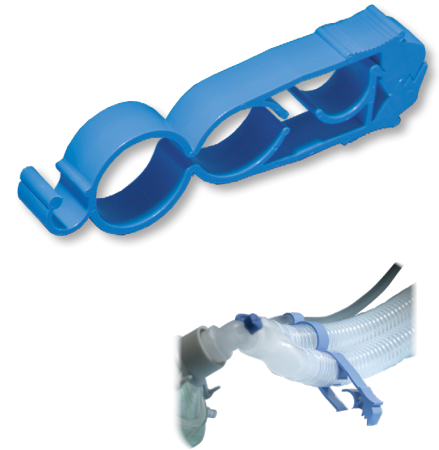

Product #	Description	Qty
JLC-3NS	Breathing Circuit Support Clamp	100/Cs

### Anesthesia Drape “Peach” Clip

- Used to attach surgical drape to IV poles to create barrier at patient’s head
- Can be used for a variety of other clamping purposes
- Heavy duty holding power that will not slip
- Wide, easy-to-grip surface
- Non-rusting components
- Multiple colors
- Not made with natural rubber latex
- Non-sterile



Product #	Description	Qty
JPC-3NS	Assorted Colors	8/Bx



# Surgical Accessories



## Equipment Covers & Drapes

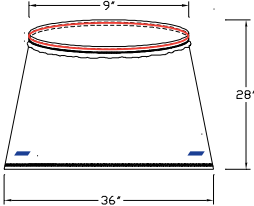
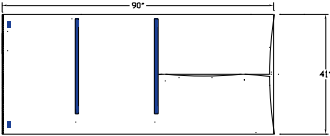
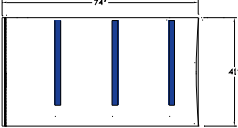

## C-Arm Drape

- Large, one-piece clear poly cover for complete coverage of C-Arm
- White poly adhesive straps secure drape in place
- Available in wide range of sizes
- Packaged with telescoping fold
- Adhesive straps included to secure excess drape material
- Not made with natural rubber latex
- Sterile

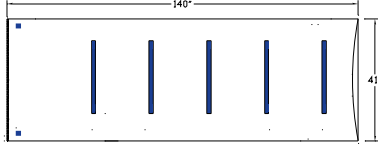
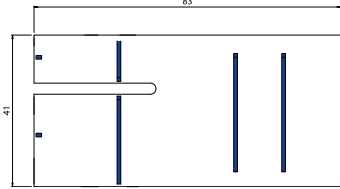
Product #	Description	Qty
30-0202	C-Arm Drape, 36" x 28" Rectangular Band Bag Style	20/Cs
		
30-0204	C-Arm Drape, 41" x 90" Mobile X-ray Drape w/ Extra Length	20/Cs
		
30-0201	C-Arm Drape, 41" x 74" Mobile X-ray Drape	20/Cs
		

Product #	Description	Qty
30-0209	C-Arm Drape, 41" x 140" Mobile X-ray Drape	10/Cs
		
30-006M	C-Arm Drape, 41" x 84" Pack w/ Keyboard & Footswitch Covers	20/Cs
		
		

### Endoscopic Camera & Laser Arm Drape

- For use in laparoscopic, arthroscopic, and hysteroscopic procedures
- Provides sterile barrier
- Protects expensive equipment by eliminating need to sterilize camera
- Neatly fits around endoscope attached to camera
- Telescopic fold with cuff for easy draping and full cord coverage
- Allows visualization all the way through the drape's end
- Non-latex containing rubber bands and adhesive strips for secure closure
- Clear elasticized fenestration for secure fit on elasticized tip version
- Not made with natural rubber latex
- Sterile



Product #	Description	Quantity	
28-0401	Camera Drape, Laser Arm, 7" x 96" Blue Elasticized Tip, 1/4" Opening	60/Cs	
28-0402	Camera Drape, Laser Arm, 5" x 96" Perforated Tip, 2" Opening	20/Cs	

Tape
  Elasticized

# Surgical Accessories

## Equipment Covers & Drapes

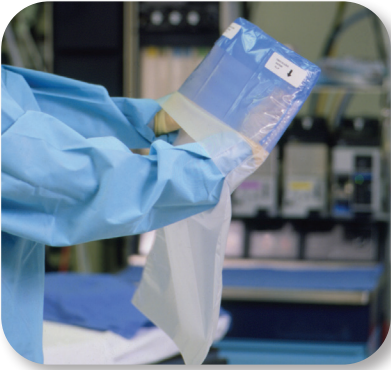

### X-ray Cassette Covers and Liners

- Clear poly bag with wide adhesive strip for closure
- Several sizes to fit a broad range of cassette widths and lengths
- Double Cassette Drape available with unique closure to ensure sterility
- Pull-away liner reduces chance of contamination once cassette is inserted
- Not made with natural rubber latex
- Sterile

Product #	Description	Qty
30-0101	X-ray Cassette Cover w/ Adhesive Strip, 24" x 25", Standard	20/Cs
30-0102	X-ray Cassette Cover w/ X-large Cuff, 21" x 40"	20/Cs



Step 1: Grasp both corners of drape to unfold. Position hands inside cuff at each corner in accepting position.



Step 2: Spread drape apart to allow accepted cassette to gently slide to bottom of drape.



Step 3: Fully extend drape.



Step 4: Fold drape until cuff fits opposite end of cassette.

# Surgical Accessories

## Equipment Covers & Drapes

Product #	Description	Quantity	
30-0103	X-ray Cassette Cover w/ Release Liner, 20" x 24"	20/Cs	
30-0104	X-ray Cassette Cover w/ Release Liner, 24" x 23"	20/Cs	



Step 1: Position hands under white corner cuffs and spread drape apart to accept cassette.



Step 2: Insert cassette into drape through blue liner.



Step 3: Carefully remove liner by grasping outer sleeve and pulling up.



Step 4: Gently slide cassette to the bottom of the drape.



Step 5: Unfold white cuff.



Step 6: Fold cuff over cassette edge to close drape.

# Surgical Accessories

## Equipment Covers & Drapes

### Flouroscope/Banded Bags

- Clear polyethylene maintains sterility in Cath labs
- Ensures sterility and protects equipment during procedures
- A wide range of sizes available
- Can be used for many applications in Surgery, Special Procedure Labs, Labor & Delivery, G.I. Labs, Radiology, Emergency Department, and others
- Rectangular, square, and round configurations
- Not made with natural rubber latex
- Sterile

#### Rectangular or Square Style

Product #	Description	Length	Width	Unstretched Opening	Qty
77-103020T	Band Bag w/ Rubberband & Tape	30"	20"	7"	25/Cs
77-103030T	Band Bag w/ Rubberband & Tape	30"	30"	7"	25/Cs
77-103036T	Band Bag w/ Rubberband & Tape	36"	30"	9"	25/Cs
77-103620T	Band Bag w/ Rubberband & Tape	36"	20"	7"	25/Cs
77-103630T	Band Bag w/ Rubberband & Tape	30"	36"	9"	25/Cs
77-103636T	Band Bag w/ Rubberband & Tape	36"	36"	9"	25/Cs
77-103640T	Band Bag w/ Rubberband & Tape	36"	48"	9"	25/Cs
77-104030T	Band Bag w/ Rubberband & Tape	40"	30"	9"	25/Cs
77-104040T	Band Bag w/ Rubberband & Tape	40"	40"	9"	25/Cs
77-104060T	Band Bag w/ Rubberband & Tape	40"	60"	9"	25/Cs

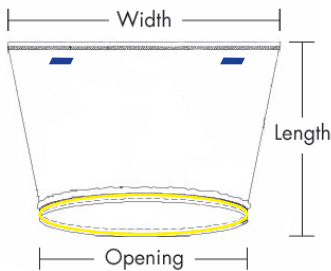

#### Bouffant Style

Product #	Description	Depth	Qty
77-100012	Band Bag, Round w/ Sewn Elastic, Medium	22"	25/Cs
77-100013	Band Bag, Round w/ Sewn Elastic, Large	27"	25/Cs
77-100025	Band Bag, Round w/ Sewn Elastic, X-Large	50"	25/Cs

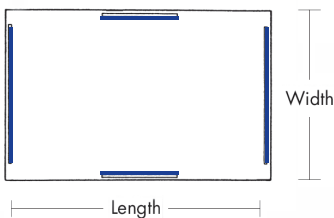
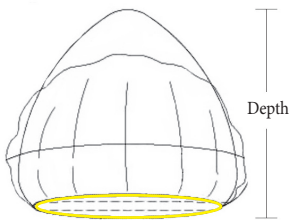

### Isolation Drape

- High quality, soft, flexible material that is strong and puncture-resistant
- High tensile strength and elongation properties ensure the safety of the sterile environment without tearing
- Only for use with the tissue or organ removed from the body but not to be put back in the body cavity
- Useful to isolate distal portions of extremities from contamination
- Other uses include the transport of specimens and to protect equipment during procedures and storage
- Moisture-proof surface prevents fluid loss through evaporation
- Draw string to enclose organs to be kept moist once removed from the body but not to be put back in the body cavity
- Impervious vinyl film bag allows the visualization of organs at all times
- Protects intestines against trauma and contamination when removed from the abdominal cavity during surgery but not to be put back in the body cavity
- Not made with natural rubber latex
- Sterile



Product #	Description	Qty
30-5510	Clear, 20" x 20"	40/Cs

### Slush Drape

- Maintains sterile field
- Facilitates proper slush production and consistency
- Excellent and economical for cardiac and transplant procedures
- Not made with natural rubber latex
- Sterile

Product #	Description	Qty
30-0602	Slush Drape, 54" x 54" (for use under sterile basin)	50/Cs





# Surgical Accessories

## Equipment Covers & Drapes



### Case Cart Cover

- Non-sterile, 2 mil cover for critical items on case carts
- Clear poly perforated bag keeps items in place
- Not made with natural rubber latex

Product #	Description	Qty
32-1385NS	Clear, 48" x 72"	100/Cs
32-1386NS	Opaque, 48" x 72"	100/Cs

### Foot Switch Cover

- Non-sterile poly drawstring bag with two layers to protect OR foot controls from fluids
- Provides clarity for surgeon when operating foot controls
- Not made with natural rubber latex

Product #	Description	Qty
30-0301NS	16" x 18" x 3"	200/Cs

### Esmark Bandages

- Excellent compression and elastic properties for limb exsanguination
- Advanced washing technology results in minimum powder
- Minimizes chances of allergic reactions
- Not made with natural rubber latex



Sterile Product #	Non-Sterile Product #	Dimensions	Description	Qty
35-304	—	3 in x 4 ft	Blue	20/Cs
35-309	35-309NS	3 in x 9 ft	Blue	20/Cs
30-194	—	3 in x 9 ft	Tan	20/Cs
35-312	—	3 in x 12 ft	Blue	20/Cs
30-195	—	3 in x 12 ft	Tan	20/Cs
35-404	—	4 in x 4 ft	Blue	20/Cs
35-409	35-409NS	4 in x 9 ft	Blue	20/Cs
30-196	—	4 in x 9 ft	Tan	20/Cs
35-412	35-412NS	4 in x 12 ft	Blue	20/Cs
30-197	—	4 in x 12 ft	Tan	20/Cs
35-604	—	6 in x 4 ft	Blue	20/Cs
35-609	35-609NS	6 in x 9 ft	Blue	20/Cs
30-198	—	6 in x 9 ft	Tan	20/Cs
35-612	35-612NS	6 in x 12 ft	Blue	20/Cs
30-199	—	6 in x 12 ft	Tan	20/Cs

### Cohesive Bandages

- Self-adherent closure
- Easy to tear
- Not made with natural rubber latex
- Sterile



Product #	Dimensions	Qty
30-422	2 in x 5 yd	20/Cs
30-423	3 in x 5 yd	20/Cs
30-424	4 in x 5 yd	20/Cs
30-426	6 in x 5 yd	20/Cs

### Coban™ Cohesive Bandages

- Self-adhering, clings only to itself for easy application
- Makes a great dressing over-wrap
- Can be quickly torn to exact length, eliminating cutting
- Sterile

Product #	Dimensions	Qty
32-665	1 in x 5 yd	20/Cs
30-402	2 in x 5 yd	20/Cs
30-403	3 in x 5 yd	20/Cs
30-404	4 in x 5 yd	20/Cs
30-406	6 in x 5 yd	20/Cs



# Surgical Accessories

## Bandages



### Elastic Bandages

- Made from high quality elastic
- Used for over-wrapping compression dressings following extremity surgery
- Superior patient comfort and breathability
- Requires less force to stretch while providing maximum compression
- Greater range of stretch power allows clinicians to set compression
- Long-stretch bandages
- Honeycomb texture provides even greater stretch with greater compression range
- Honeycomb texture has scalloped edges to prevent rolling
- Available with either metal clip or hook and loop closure
- Not made with natural rubber latex



#### Metal Clip Sterile

Product #	Non-Sterile Product #	Dimensions	Description	Qty
9825-00	9825-00NS	2 in x 5 yd	Tan	20/Cs
9825-09	—	2 in x 5 yd	Economy White	50/Cs
9835-00	9835-00NS	3 in x 5 yd	Tan	20/Cs
9835-09	—	3 in x 5 yd	Economy White	50/Cs
9845-00	9845-00NS	4 in x 5 yd	Tan	20/Cs
9845-09	—	4 in x 5 yd	Economy White	50/Cs
9845-10	—	4 in x 10 yd	Tan	20/Cs
9865-00	9865-00NS	6 in x 5 yd	Tan	20/Cs
9865-09	—	6 in x 5 yd	Economy White	50/Cs
9865-10	9865-10NS	6 in x 10 yd	Tan	20/Cs

#### Hook & Loop Sterile

Product #	Non-Sterile Product #	Dimensions	Description	Qty
9810-25	—	2 in x 5 yd	Tan	20/Cs
—	9811-25	2 in x 5 yd	Tan	10/Cs
9810-35	—	3 in x 5 yd	Tan	20/Cs
—	9811-35	3 in x 5 yd	Tan	10/Cs
9810-45	—	4 in x 5 yd	Tan	20/Cs
—	9811-45	4 in x 5 yd	Tan	10/Cs
9810-65	—	6 in x 5 yd	Tan	20/Cs
—	9811-65	6 in x 5 yd	Tan	10/Cs
9812-610	—	6 in x 10 yd	Tan	20/Cs
—	9812-610NS	6 in x 10 yd	Tan	100/Cs



#### Double Hook & Loop

Product #	Non-Sterile Product #	Dimensions	Description	Qty
9710-25	9710-25NS	2 in x 5 yd	Honeycomb	20/Cs
9710-35	—	3 in x 5 yd	Honeycomb	20/Cs
9710-45	9710-45NS	4 in x 5 yd	Honeycomb	20/Cs
9710-65	9710-65NS	6 in x 5 yd	Honeycomb	20/Cs

### Cast Padding

- High-quality, sterile padding
- Comes in a wide variety of sizes
- Available in cotton, rayon, or cotton/rayon blend
- Excellent for use when dressing an extremity
- Not made with natural rubber latex



Cotton Cast  
Padding

Specialist\*  
Padding



Sof-Rol\*  
Padding

Cotton	Specialist® Blend	Sof-Rol® Rayon	Size	Sterile	Qty
30-245	30-319	30-325	2 in x 4 yd	Sterile	20/Cs
30-245NS	30-319NS	30-325NS	2 in x 4 yd	Non-Sterile	100/Cs
30-226	30-320	30-326	3 in x 4 yd	Sterile	20/Cs
30-226NS	30-320NS	30-326NS	3 in x 4 yd	Non-Sterile	100/Cs
30-227	30-321	30-327	4 in x 4 yd	Sterile	20/Cs
30-227NS	30-321NS	30-327NS	4 in x 4 yd	Non-Sterile	100/Cs
30-228	30-322	30-328	6 in x 4 yd	Sterile	20/Cs
30-228NS	30-322NS	30-328NS	6 in x 4 yd	Non-Sterile	100/Cs

### Impervious Stockinette

- Available in multiple sizes
- Available with pull tabs for easier application
- Premium grade liner for superior strike-through prevention
- Soft and highly elastic impervious liner
- Polyester and cotton options
- Not made with natural rubber latex



Sterile	Dimensions	Description	Material	Qty
9978-06	7 in x 34 in	w/ EZ Pull Tabs	Cotton	20/Cs
9816-36	7 in x 34 in	w/o EZ Pull Tabs	Cotton	20/Cs
9408-38	8 in x 38 in	w/o EZ Pull Tabs	Polyester	40/Cs
9978-09	9 in x 48 in	w/ EZ Pull Tabs	Cotton	20/Cs
9977-09	9 in x 48 in	w/o EZ Pull Tabs	Cotton	20/Cs
9409-54	9 in x 48 in	w/o EZ Pull Tabs	Polyester	40/Cs
9978-12	12 in x 48 in	w/ EZ Pull Tabs	Cotton	20/Cs
9816-54	12 in x 48 in	w/o EZ Pull Tabs	Cotton	20/Cs
9412-54	12 in x 48 in	w/o EZ Pull Tabs	Polyester	40/Cs
9978-16	16 in x 48 in	w/ EZ Pull Tabs	Cotton	20/Cs
9818-54	16 in x 48 in	w/o EZ Pull Tabs	Cotton	20/Cs
9416-54	16 in x 48 in	w/o EZ Pull Tabs	Polyester	40/Cs

Non-Sterile	Dimensions	Description	Material	Qty
9977-09NS	9 in x 48 in	w/o EZ Pull Tabs	Cotton	20/Cs
9816-54NS	12 in x 48 in	w/o EZ Pull Tabs	Cotton	20/Cs
9818-54NS	16 in x 48 in	w/o EZ Pull Tabs	Cotton	20/Cs

# Surgical Accessories

## Stockinette



Standard

## Standard Stockinette

- Comes in a wide variety of sizes
- Available with pull tabs for easy application
- Wax coated for added fluid repellency
- Off-white color reduces glare from OR lights
- Available in single or double ply
- Not made with natural rubber latex



EZ Pull Tabs

### Sterile

Single Ply	Double Ply	w/ EZ Pull Tabs Double Ply	Dimensions	Qty
9502-36	9602-36	—	2 in x 36 in	20/Cs
9503-36	9603-36	—	3 in x 36 in	20/Cs
9503-54	—	—	3 in x 54 in	20/Cs
9504-36	9604-36	9704-36	4 in x 36 in	20/Cs
9504-48	9604-48	9704-48	4 in x 48 in	20/Cs
9504-60	9604-60	—	4 in x 60 in	20/Cs
9506-36	—	—	6 in x 36 in	20/Cs
9506-48	9606-48	9706-48	6 in x 48 in	20/Cs
—	9606-54	—	6 in x 54 in	20/Cs
9506-60	9606-60	9706-60	6 in x 60 in	20/Cs
9506-72	9606-72	9606-72	6 in x 72 in	20/Cs
9508-48	9608-48	—	8 in x 48 in	20/Cs
9508-60	9608-60	9708-60	8 in x 60 in	20/Cs
9508-72	9608-72	9708-72	8 in x 72 in	20/Cs
9510-48	9610-48	—	10 in x 48 in	20/Cs
9510-60	—	—	10 in x 60 in	20/Cs

### Non-Sterile

Single Ply	Double Ply	w/ EZ Pull Tabs Double Ply	Dimensions	Qty
9504-36NS	9604-36NS	9704-36NS	4 in x 36 in	20/Cs
9504-48NS	9604-48NS	9704-48NS	4 in x 48 in	20/Cs
—	9606-54NS	—	6 in x 54 in	20/Cs
9506-60NS	9606-60NS	—	6 in x 60 in	20/Cs
—	9606-72NS	9706-72NS	6 in x 72 in	20/Cs
—	9608-72NS	—	8 in x 72 in	20/Cs

### Shoulder Arthroscopy II Kit

- Complete kit for shoulder arthroscopies
- Convenient bundles ready when needed
- Time and cost savings
- Can be customized to meet your specifications
- Not made with natural rubber latex
- Sterile



Product #	Description	Qty
89-5041*	Shoulder Arthroscopy II	3/Cs
	1 Absorbent Towel	
	1 Back Table Cover, 50" x 90"	
	1 Blade, #11	
	1 Blade, #15	
	1 Drape, Impervious Split, 60" x 70"	
	1 Shoulder Arthroscopy Drape w/Pouch, 100" x 60"	
	2 Drapes, Utility w/ Tape, 15" x 26"	
	1 Emesis Basin	
	20 Gauze Pads, 12-Ply, 4" x 4"	
	1 Gown, X-large	
	1 Gown, X-large, Full Impervious MicroCool	
	5 Lap Sponges w/ Loop, 18" x 18"	
	1 Mayo Stand Cover	
	1 Needle, 18 ga x 1 1/2"	
	1 Needle Counter, 20 Count	
	1 Needle, Spinal, 20 GA x 3 1/2"	
	11 OR Towels, Blue	
	1 Ring Basin	
	1 Self-Adherent Wrap, 4" Roll	
	1 Stockinette, Impervious, 9" x 48"	
	1 Suction Tubing, 12'	
	1 Suture Bag	
	1 Syringe, 50 cc L/L	

### Shoulder Suspension Kits

- Specially designed shoulder suspension stockinette
- Traction cord with S-hook
- Kit contains 1 each of the following: Tray, .306" diameter S hook, stockinette, traction cord, 4"x 5 yd cohesive wrap
- 10/Cs
- Not made with natural rubber latex
- Sterile



Product #	Tray	Stockinette	Traction Cord	Cohesive Wrap
32-847	Tray Large Deep 9.75 in x 5.5 in x 2 in	Cotton Blend 6"	7 Ft	DeRoyal®
32-1796	Half Tray Shallow 9.75 in x 5.5 in x 1 in	Cotton Blend 8"	8 Ft	COBAN™
32-1746	Half Tray Shallow 9.75 in x 5.5 in x 1 in	Cotton Blend 10"	8 Ft	COBAN™
32-525	Half Tray Shallow 9.75 in x 5.5 in x 1 in	Cotton Blend 8"	8 Ft	DeRoyal®
32-526	Half Tray Shallow 9.75 in x 5.5 in x 1 in	Cotton Blend 8"	8 Ft	COBAN™

**⚠️**\*WARNING- This product can expose you to chemicals including Ethylbenzene, which is known to the State of California to cause cancer, and Toluene, which is known to the State of California to cause birth defects or other reproductive harm. For more information, go to [www.P65Warnings.ca.gov](http://www.P65Warnings.ca.gov).



# Surgical Accessories

## Suspension Kits



## Knee Arthroscopy II Kit

- Complete kit for knee arthroscopies
- Convenient bundles ready when needed
- Time and cost savings
- Can be customized to meet your specifications
- Not made with natural rubber latex
- Sterile

Product #	Description	Qty
89-5032*	Knee Arthroscopy II	5/Cs
	1 Absorbent Towel	
	1 Back Table Cover, 44" x 90"	
	1 Elastic Bandage, 4" Roll	
	1 Elastic Bandage, 6" Roll	
	1 Blade, #11	
	1 Drape, Impervious Split, 60" x 70"	
	1 Drape, Knee Arthroscopy w/ Pouch, 90" x 124"	
	1 Emesis Basin	
	1 Card Episeal Strips, ¼" x 3"	
	1 Flultex Bandage, 4½" Roll	
	20 Gauze Pads, 12-Ply, 8" x 4"	
	1 Gown, X-large	
	1 Gown, X-large, Full Impervious MicroCool	
	1 Mayo Stand Cover	
	1 Needle, Spinal, 18 GA x 1 1/2"	
	1 Needle, Spinal, 25 GA x 1 1/2"	
	1 Needle Counter, 20 Count	
	9 OR Towels, Blue	
	1 Ring Basin	
	1 Self-Adherent Wrap, 4" Roll	
	1 Stockinette, Impervious, 12" x 48"	
	1 Suction Tubing, 12'	
	1 Suture Bag	
	1 Syringe, 50 cc L/L	

 \*WARNING- This product can expose you to chemicals including Elhylbenzene, which is known to the State or California to cause cancer, and Toluene, which is known to the State of California to cause birth defects or other reproductive harm. For more information, go to [www.P65Warnings.ca.gov](http://www.P65Warnings.ca.gov).



### SPEyes™ X Eye Protection

- Saf-T-Ledge™ Top-Down Protection
- Extended wrap around lens exceeds other competitors' coverage
- Double-sided anti-fog lens
- Uniquely-shaped lens to reduce glare
- Snap design creates a closed system for additional fluid protection
- Contoured frame shape for a comfortable fit even over prescription glasses
- Not made with natural rubber latex

Product #	Description	Qty
23-500	SPEyes™ X Kit	25 Frames/100 lenses
23-501	SPEyes™ X Lenses	100/Bx
23-502	SPEyes™ X Frames	25/Bx
23-504	Lens and Mounting Bracket	1/Ea
23-505	SPEyes™ X Assembled	10/Bg, 10 Bgs/Cs
23-506	SPEyes™ X Assembled in Dispenser Box	30/Bx, 4 Bxs/Cs
23-507	Dispenser Box Bracket	1/Ea



### SPEyes™ S Protective Eye Wear

- Thread through design
- Single-use lightweight lens
- Anti-fog and anti-glare on both sides of lens
- Wrap-around frame design for a comfortable fit
- Frame features lens lock securement
- Not made with natural rubber latex

Product #	Description	Qty
23-701	SPEyes™ S Lenses	100/Cs
23-702	SPEyes™ S Frames	25/Cs



### DeRoyal® Face Shields

- Anti-fog on both sides of lens
- Accommodates eyeglasses and face mask
- Elastic strap for secure fit
- Not made with natural rubber latex

Product #	Description	Qty
23-201	Solid Foam w/ Elastic Strap	42 Ea/Bx, 4 Bxs/Cs
23-005	Half Shield, Vented Foam w/ Hook and Loop Strap	50/Cs

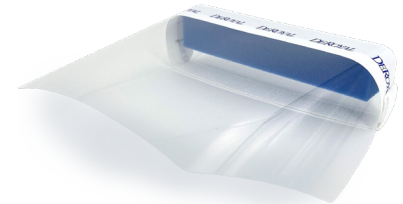



### Protective Goggles

- Sturdy, comfortable, and snug-fitting fluid eye protection
- Vented for additional comfort, indirect fluid protection, and reduced fogging
- Optical quality lens for visual clarity
- Easily adjustable elastic strap
- Meets ANSI Z87.1 standards
- 99% U.V. Protective
- Not made with natural rubber latex

Product #	Description	Qty
23-310	Protective Goggles	100/Cs



### Protective Glasses

- Clear, lightweight plastic glasses for fluid protection with the easy off/on convenience of glasses
- Optical quality lens for visual clarity
- Fits comfortably over prescription glasses
- Meets ANSI Z87.1 standards
- 99% U.V. Protective
- Not made with natural rubber latex

Product #	Description	Qty
23-300	Protective Glasses	100/Cs



### Patient Eye Shield

- Transparent, rigid lenses are uniquely contoured to deflect objects away from the patient's eyes
- Protects eyes from blood, fluid, and other foreign material
- Flexible self-adhesive foam creates a protective seal minimizing risk of infection
- Easy application and removal
- Not made with natural rubber latex
- Sterile

Product #	Description	Qty
23-600	Patient Eye Shield	25/Cs

### Deluxe Needle Counters

- Full-surface magnet provides extra space for odd-shaped sharps, pins, blades, or needles
- Numbers on magnet allow easy sharps placement and positioning
- Easy-to-read numbers and descriptions facilitate correct count of blades and needles
- See-through cover available, allowing clear box visualization when closed
- Red color signifies biohazard waste
- Not made with natural rubber latex
- Sterile

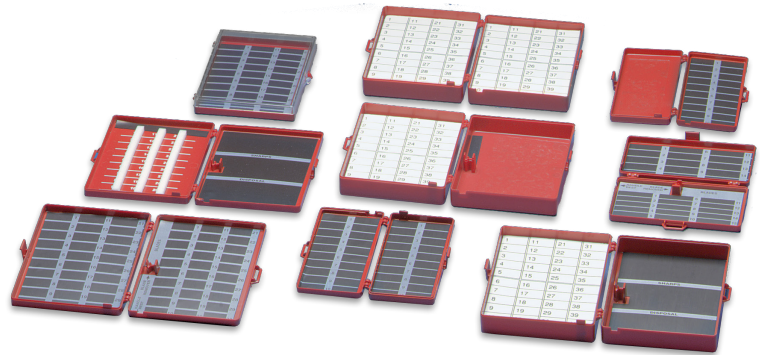

#### Magnet

Product #	Description	Qty
25-0101*	Double Magnet (20 Count 40 Capacity)	50 Pks/Bx, 2 Bxs/Cs
25-0104*	Double Magnet (30 Count 60 Capacity)	50 Pks/Bx, 2 Bxs/Cs
25-0108*	Double Magnet (60 Count 120 Capacity)	27 Pks/Bx, 4 Bxs/Cs
25-0108W*	Double Magnet (60 Count 120 Capacity) "White Magnet"	27 Pks/Bx, 4 Bxs/Cs
25-0201*	Magnet/Adhesive (10 Count 20 Capacity)	50 Pks/Bx, 2 Bxs/Cs

#### Magnet/Foam Combo

Product #	Description	Qty
25-0401*	Magnetic/Foam (20 Count 40 Capacity)	20 Pks/Bx, 4 Bxs/Cs
25-0402*	Magnetic/Foam (10 Count 20 Capacity)	25 Pks/Bx, 4 Bxs/Cs
25-0403*	Magnetic/Foam (40 Count 80 Capacity)	12 Pks/Bx, 4 Bxs/Cs
25-0701*	Foam Strips/Magnetic (15 Count 30 Capacity)	50 Pks/Bx, 2 Bxs/Cs
25-0702*	Magnetic/Foam (30 Count 60 Capacity)	27 Pks/Bx, 4 Bxs/Cs

#### Foam

Product #	Description	Qty
25-0301*	Double Foam (80 Count 160 Capacity)	12 Pks/Bx, 4 Bxs/Cs
25-0501*	Foam/Adhesive (10 Count 20 Capacity)	25 Pks/Bx, 4 Bxs/Cs
25-0502*	Foam/Adhesive (20 Count 40 Capacity)	20 Pks/Bx, 4 Bxs/Cs
25-0504*	Foam/Adhesive (40 Count 80 Capacity)	12 Pks/Bx, 4 Bxs/Cs
25-0801*	Foam Strips (30 Count 60 Capacity)	50 Pks/Bx, 2 Bxs/Cs
25-0803*	Foam Strips (60 Count 120 Capacity)	27 Pks/Bx, 4 Bxs/Cs

#### Clear Top

Product #	Description	Qty
25-0103*	Single Magnet/Clear Top (10 Count 20 Capacity)	50 Pks/Bx, 2 Bxs/Cs
25-0105*	Single Magnet/Clear Top (30 Count 60 Capacity)	27 Pks/Bx, 4 Bxs/Cs
25-0802*	Foam Strips (15 Count 30 Capacity)	50 Pks/Bx, 2 Bxs/Cs

 \*WARNING- This product can expose you to chemicals including Ethylbenzene, which is known to the State or California to cause cancer, and Toluene, which is known to the State of California to cause birth defects or other reproductive harm. For more information, go to [www.P65Warnings.ca.gov](http://www.P65Warnings.ca.gov).

# Safety Solutions

## OR Safety Management



Step 1: Insert blade into DeBlade™ mechanism.



Step 2: Slide forward until blade “catches.”



Step 3: Slide backward until blade drops safely into box.

## DeBlade™ Needle Counters

- Full-surface magnet provides extra space for odd-shaped sharps, pins, blades, or needles
- Scalpel handle guide facilitates use of the blade remover
- Overlapping box edges prevent sharps from escaping when closed
- Numbers on magnet allow easy sharps placement and positioning
- Easy-to-read numbers and descriptions facilitate correct count of blades and needles
- User passive locking latch engages automatically to prevent inadvertent opening
- Red color signifies biohazard waste
- Not made with natural rubber latex
- Sterile

### Magnet

#### Product #

25-1104\*

25-1108\*

#### Description

Double Magnet (30 Count 60 Capacity)

Double Magnet (60 Count 120 Capacity)

#### Qty

50 Pks/Bx, 2 Bxs/Cs

27 Pks/Bx, 4 Bxs/Cs

### Foam/Magnet Combo

#### Product #

25-1401\*

25-1403\*

25-1702\*

25-1701\*

#### Description

Foam Block/Magnetic (20 Count 40 Capacity)

Foam Block/Magnetic (40 Count 80 Capacity)

Foam Strips/Magnetic (30 Count 60 Capacity)

Foam Strips/Magnetic (15 Count 30 Capacity)

#### Qty

20 Pks/Bx, 4 Bxs/Cs

12 Pks/Bx, 4 Bxs/Cs

27 Pks/Bx, 4 Bxs/Cs

50 Pks/Bx, 2 Bxs/Cs

### Foam

#### Product #

25-1502\*

25-1801\*

#### Description

Foam Block/Adhesive (20 Count 40 Capacity)

Foam Strips (30 Count 60 Capacity)

#### Qty

20 Pks/Bx, 4 Bxs/Cs

25 Pks/Bx, 4 Bxs/Cs

## Scalpel Blade Remover

- Safely removes blade from metal scalpel handle and contains it for disposal in a sharps container
- Place on the Mayo Stand or back table in open position for fast, safe blade removal
- Hinged plastic sheath securely locks and contains blade
- Compatible with all scalpel blades and handles
- Single use device
- Not made with natural rubber latex

#### Product #

D6200

D6200NS

#### Description

Blade Remover, Sterile

Blade Remover, Non-Sterile

#### Qty

50/Cs

100/Cs

 \*WARNING- This product can expose you to chemicals including Ethylbenzene, which is known to the State or California to cause cancer, and Toluene, which is known to the State of California to cause birth defects or other reproductive harm. For more information, go to [www.P65Warnings.ca.gov](http://www.P65Warnings.ca.gov).



### Disposable Safety Scalpels

- Controlled retraction of the entire blade
- Safe and easy to open with temporary forward locking to prevent accidental retractions
- Permanent spring lock position for disposal
- Multiple stainless steel blade sizes with color-coded sliders for easy identification
- #4 handle houses larger stainless steel blades
- Ribbed, slip-resistant finger grips for a secure hold in gloved hands, accommodating a variety of hand positions
- High-visibility red color denotes a biohazard to ensure proper disposal in sharps container
- Full blade visibility at all times to reduce the chance of accidental injury
- Designed by a cardiovascular surgeon in conjunction with a safety engineer
- Clinically reviewed and industry-listed as sharps safety device meeting OSHA requirements
- Not made with natural rubber latex
- Available sterile and non-sterile



#3 Handle



#4 Handle

	<b>Sterile</b>	<b>Non-Sterile</b>	<b>Description</b>	<b>Qty Sterile</b>	<b>Qty Non-Sterile</b>
D4510	D4510NS		#10 Safety Scalpel, Black Slider, #3 Handle	50/Cs	100/Cs
D4511	—		#11 Safety Scalpel, Blue Slider, #3 Handle	50/Cs	—
D45E11	—		#E11 Safety Scalpel, Orange Slider, #3 Handle	50/Cs	—
D4515	D4515NS		#15 Safety Scalpel, Green Slider, #3 Handle	50/Cs	100/Cs
D4515C	—		#15C Safety Scalpel, Brown Slider, #3 Handle	50/Cs	—
D4516	—		#16 Safety Scalpel, White Slider, #3 Handle	50/Cs	—
D4520	D4520NS		#20 Safety Scalpel, Grey Slider, #4 Handle	50/Cs	100/Cs
D4521	D4521NS		#21 Safety Scalpel, Lilac Slider, #4 Handle	50/Cs	100/Cs
D4522	D4522NS		#22 Safety Scalpel, Sky Blue Slider, #4 Handle	50/Cs	100/Cs
D4524	D4524NS		#24 Safety Scalpel, Orange Slider, #4 Handle	50/Cs	100/Cs

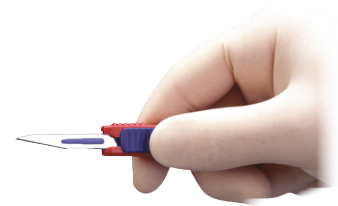
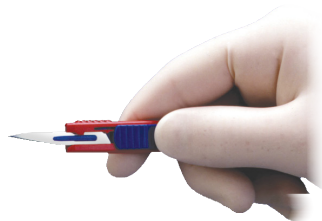



### Safety Strainers

- Allows the removal of contaminated instruments from basins without requiring personnel to place hands in contaminated fluid
- Fits standard ring basins
- Does not interfere with normal ring basin use
- Not made with natural rubber latex
- Sterile

Product #	Description	Qty
89-5014	Rigid Strainer	8/Cs



### SharpStop™ Sharps Transfer Tray

- A disposable device to transfer and pass commonly used sharp instruments
- Use where controls are required to reduce employee exposure to bloodborne pathogens
- Helps to prevent sharps injuries during invasive procedures
- Facilitates compliance to OSHA Directive CPL 2-244D
- Accommodates wide range of scalpels, sutures, trocars, forceps, K-wires, syringes, and retractors
- Underside accommodates the practical positioning and safe passing of multiple instruments
- Accommodates handle sizes 3, 4, 5, 7, and 9 with loaded scalpel blades 10, 11, 12, 15, 20, 22, and 23
- Center finger guide cradles scalpel for safe removal
- Sloping sides automatically rotate and direct dropped scalpels into safety position
- Specially designed central recess is wide enough to accommodate scalpel blades but does not allow fingers to touch blades
- Not made with natural rubber latex

Product #	Description	Qty
25-2244	Sharps Transfer Tray	24/Cs
25-2244NS	Sharps Transfer Tray, Non-Sterile	24/Cs
25-2244V*	Sharps Transfer Tray w/ Hook and Loop	24/Cs



**⚠️**\*WARNING- This product can expose you to chemicals including Ethylbenzene, which is known to the State or California to cause cancer, and Toluene, which is known to the State of California to cause birth defects or other reproductive harm. For more information, go to [www.P65Warnings.ca.gov](http://www.P65Warnings.ca.gov).





# Labor and Delivery

## Basin Sets



## Vaginal Delivery Convenience Kit

- All supplies needed for a vaginal delivery
- Quick set-up saves vital time
- Not made with natural rubber latex to minimize reactions in patients and clinicians
- A variety of Convenience Kits available
- All kits can be customized for your convenience

**Product #**  
89-5043 \*

**Description**  
Vaginal Delivery Convenience Kit

**Qty**  
8/Cs

**Kit includes:**

Baby Blanket, 1/Ea  
Back Table Cover, 44" x 78", 1/Ea  
Gauze Pads, 8" x 4", 12-Ply, X-ray, 30/Ea  
Leggings, 31" x 48" w/6" Cuff, 2/Ea  
Needle, 25-Gauge x 1½", 1/Ea  
OR Towels, Blue, 3/Ea  
Syringe, 10 cc, LL, 1/Ea  
Drape, Abdominal w/Tape, 60" x 38", 1/Ea

Baby Cap, 1/Ea  
ClearGrip™ Bulb Syringe, 1/Ea  
Gown, X-large, 1/Ea  
Medicine Cup, 1/Ea  
Maternity Pads w/Wings, 2/Ea  
Placenta Basin & Lid, 1/Ea  
Umbilical Cord Clamp, 1/Ea  
Drape, Under Buttock w/Pouch, 1/Ea

 \*WARNING- This product can expose you to chemicals including di(2-ethylhexyl)phthalate, which is known to the State of California to cause cancer and birth defects or other reproductive harm. For more information, go to [www.P65Warnings.ca.gov](http://www.P65Warnings.ca.gov).

### Placenta Basin & Lid

- Low-profile, snap-tight lid helps prevent tipping or spills during transport, disposal, or storage
- Large 12" x 9" tray allows easy inspection of placenta
- Designed for durability to prevent cracking or breakage
- Etched graduations for more accurate measurements
- Standard rectangular size for convenient placement
- Not made with natural rubber latex
- Sterile

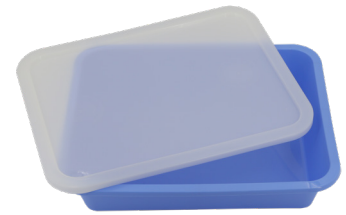

Product #	Description	Qty
32-881	Placenta Basin w/o Lid	15/Cs
32-1029	Placenta Basin w/ Lid	10/Cs

### Fetal Monitoring Abdominal Straps

- Made of durable elastic or blue purr foam to withstand extended labor
- Two straps available (with button tabs or slot straps) to accommodate transducers
- Comfortable for patient while keeping transducers in position
- Not made with natural rubber latex



Product #	Description	Qty
M1132-10	Blue Purr Foam Fetal Monitoring Straps w/ Slots, 1 $\frac{7}{8}$ " x 54"	10/Cs
M1140	Elastic Fetal Monitoring Straps w/ Button Tabs (1 Pink & 1 Blue/Set), 2 $\frac{3}{8}$ " x 48"	50 Sets/Cs
M1143	Plush Fetal Monitoring (1 Pink & 1 Blue/Set), 1 $\frac{1}{2}$ " x 36"	50 Sets/Cs

# Labor and Delivery

## Labor & Delivery Essentials



### UmbiliCup® Cord Blood Collection Device

- Cord blood collection device to safely and efficiently facilitate cord blood collection
- Use for umbilical cord sampling and blood gas collection
- Also acts as a transporting device for lab testing
- Eliminates the use of an exposed sharp needle, reducing the exposure to blood and decreasing the risk of a needle stick injury
- Not made with natural rubber latex
- Sterile

**Product #**  
72-8000

**Description**  
UmbiliCup™ Device

**Qty**  
24/Cs



Reference mark identifies the direction the hook is pointed even while inserted.

### Amniotic Membrane Perforator

- Patented ergonomic design ensures a good grip for reliable insertion and removal
- Reference mark helps identify the direction the hook is pointed, even while inserted
- Malleable, for easy insertion
- Sharp “crochet-hook” tip ruptures sac easily and effectively
- Not made with natural rubber latex

**Product #**  
72-7100

**Description**  
Sterile

**Qty**  
100/Cs

### Satchel Sheet

- A floor drape for fluid control
- Improves safety of staff by helping to provide non-slip area
- Prevents tracking of fluids in delivery room
- Two layers of absorbent non-woven material with plastic backing
- “Peel and stick” edges secure corners to floor and help prevent slippage
- Pull cord design allows easy disposal
- Available in two convenient sizes to fit any L&D room or suite
- Not made with natural rubber latex
- Non-sterile



Product #	Description	Qty
59-0803NS	Regular, 60" x 100"	10/Cs
59-0900NS	Mini, 60" x 64"	20/Cs

### Under Buttocks Drape

- Drape is made with non-woven inserts to cushion back and hips
- Ultra absorbent materials wick away moisture to help keep patient dry and comfortable
- Reduces the number of bed changes
- Not made with natural rubber latex
- Sterile



Product #	Description	Qty
59-0806	77" x 18" x 32"	20/Cs

### Supreme Under Buttocks Drape

- One of the most absorbent drapes available for delivery
- Features pouch area to catch fluids
- Ideal for use in late labor as well as delivery
- Impervious backing and foam insert help prevent fluids from backwashing under patient
- Saves linens and clean up time
- Not made with natural rubber latex
- Sterile



Product #	Description	Qty
59-0802	32" x 50"	10/Cs



## Clear Grip™ Baby Syringe Aspirator

- Easy-to-hold syringe
- Made of clear, flexible rubber to establish quantity, color, and type of aspirated fluid
- Side grippers for a firm non-slip hold
- Gentle safety tip with firm suction power for thorough extraction
- Clear bulb ensures complete emptying and cleaning
- 60 cc (2 oz) syringe
- Available with standard or narrow tip
- Not made with natural rubber latex
- Sterile

Product #	Description	Qty
32-1328	Standard Tip	24/Cs
32-1328NT	Narrow Tip	24/Cs



## Baby Caps

- Soft spun polyester yarn gently cuffs baby's head
- Knitted in a small pattern sequence to prevent heat loss
- Double-ply, surgical-grade knitting
- Not made with natural rubber latex
- Non-sterile

Product #	Description	Qty
32-1335NS	White	100/Cs
32-1336NS	Pink & Blue Striped	100/Cs

### Umbilical Cord Clamp

- Snap-tight closure
- Clamp tested to over 11 lbs of pull-force
- Not made with natural rubber latex
- Available in sterile and non-sterile

Product #	Description	Qty
6833	Cord Clamp w/ 2 Clamp Cutters	50/Bx, 2 Bxs/Cs
6833-B	Cord Clamp w/ 1 Clamp Cutter	1000/Cs
6833NS	Cord Clamp w/ 2 Clamp Cutters	1000/Cs



### Umbilical Clamp Cutter

- Clamp cutter available for easy cord clamp removal
- Disposable
- Not made with natural rubber latex
- Non-sterile

Product #	Description	Qty
72-7000	Clamp Cutter	6/Bx
72-7000B	Clamp Cutter	200/Cs



### Umbilical Tape

- Flat, sterile cotton tape for tying off umbilical cord stump
- Available in three pre-cut lengths
- Non radiopaque

Product #	Description	Qty
30-409	1/8" x 18"	100/Cs
31-251	1/8" x 30"	100/Cs
30-410	1/8" x 45"	100/Cs



# Labor and Delivery

## Enteral Safe Feeding

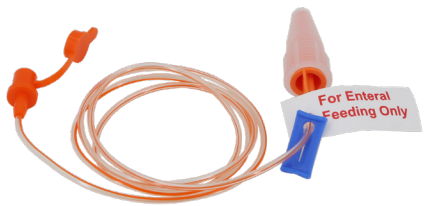

### Enteral Feeding Tube Extension Sets

- Orange striped, enteral tubing (non-DEHP)
- Orange female and male, enteral only (non-IV) connectors
- Tagged for enteral feeding only
- Not made with natural rubber latex
- Sterile

Product #	Description	Qty
54-7062	38" (96 cm), w/ 1 slide clamp, PV 1.0 ml	50/Cs
54-7066	62" (157 cm), w/ 1 slide clamp, PV 1.6 ml	50/Cs
54-7069	62" (157 cm) "Y" set, w/ 1 male & 2 female connectors, 2 slide clamps, PV 1.7 ml	50/Cs

### Enteral Feeding Syringes



- Orange, enteral only (non-IV) tips
- Fits most pumps
- Not made with natural rubber latex
- Non-sterile

Product #	Description	Qty
54-5001	1 cc Syringe	150/Cs
54-5005	5 cc Syringe	150/Cs
54-5010	10 cc Syringe	100/Cs
54-5020	20 cc Syringe	100/Cs
54-5030	30 cc Syringe	100/Cs
54-5060	60 cc Syringe	75/Cs



### Polyurethane Enteral Feeding Tubes

- Orange, enteral only (non-IV) connector
- Soft, smooth polyurethane tubing
- Orange radiopaque stripe
- Open end tubing w/ offset eyes
- Calibrated at 1 cm intervals
- Not made with natural rubber latex
- Sterile

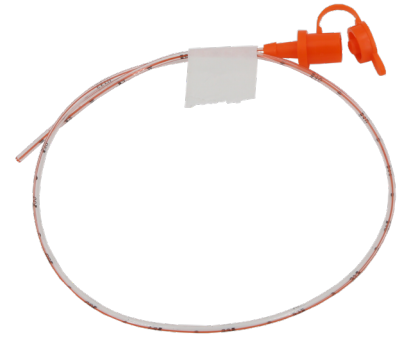

Product #	Description	Qty
54-2450R	5 FR x 24 in (60 cm)	10/Cs
54-3650R	5 FR x 36 in (91 cm)	10/Cs
54-1665R	6.5 FR x 16 in (40 cm)	10/Cs
54-3665R	6.5 FR x 36 in (91 cm)	10/Cs
54-1680R	8 FR x 16 in (40 cm)	10/Cs
54-2480R	8 FR x 24 in (60 cm)	10/Cs

### PVC Enteral Feeding Tubes

- Orange, enteral only (non-IV) connector
- Smooth PVC tubing (non-DEHP)
- Radiopaque stripe
- Closed end tubing w/offset eyes
- Calibrated at 2 cm intervals
- Not made with natural rubber latex
- Sterile

Product #	Description	Qty
54-5115R	5 FR x 15 in (38 cm)	100/Cs
54-5136R	5 FR x 36 in (91 cm)	100/Cs
54-8115R	8 FR x 15 in (38 cm)	100/Cs
54-8142R	8 FR x 42 in (107 cm)	100/Cs

# Labor and Delivery

## Blood Pressure Cuffs



## Disposable Neonatal Blood Pressure Cuffs

- A complete range of sizes from 3 cm to 15 cm
- Soft cuffs for the smallest patients
- Extra-soft material
- Adapts to 1-tube or 2-tube BP monitors
- Non-abrasive molded hook and loop closures
- Disposable
- Not made with natural rubber latex
- Non-Sterile

Product #	Description	Qty
72-3101	#1, 3-6 cm, Slip Coupling	10/Bx
72-3102	#2, 4-8 cm, Slip Coupling	10/Bx
72-3122	#2, 4-8 cm, Screw Coupling	10/Bx
72-3103	#3, 6-11 cm, Slip Coupling	10/Bx
72-3123	#3, 6-11 cm, Screw Coupling	10/Bx
72-3104	#4, 7-13 cm, Slip Coupling	10/Bx
72-3124	#4, 7-13 cm, Screw Coupling	10/Bx
72-3105	#5, 8-15 cm, Slip Coupling	10/Bx
72-3125	#5, 8-15 cm, Screw Coupling	10/Bx

\* Each case comes w/ one tube of Loctite® threadlocker.

### Neonatal Eye Covers

- Double thick for maximum comfort and protection
- Hook and loop tabs allow for easy application
- Held in place by gentle adhesive tabs complete with alcohol prep pad
- Not made with natural rubber latex
- Non-Sterile



Product #	Description	Qty
72-4100	Small/Preemie	12/Bx
72-4101	Premature	12/Bx
72-4102	Newborn	12/Bx

# Labor and Delivery

## Warming Devices

### Infant Heel Warmer



- Reaches a maximum temperature of 105° F/41° C
- Convenient ankle strap holds product in place
- Non-toxic liquid warming solution
- Comes in convenient dispenser boxes
- Made with soft, pliable material to be gentle to baby's skin
- Quick, easy activation
- Not made with natural rubber latex
- Non-Sterile

Product #	Description	Qty
HNICU-100	Infant Heel Warmer	100/Cs

### Infant Transport Mattress

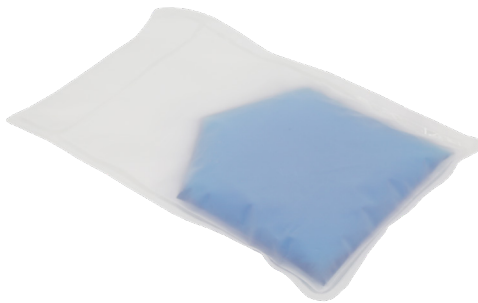

- Helps maintain loss of neonatal body heat during transport
- Reaches a maximum temperature of 105° F/41° C
- Non-toxic gel and soft material create a comfortable “nest” for baby
- Helps absorb vibration during transport
- Sturdy bag design prevents leakage during activation or use
- Not made with natural rubber latex
- Non-Sterile

Product #	Description	Qty
HNICU-200	Infant Transport Mattress	4/Cs

### IV Armboards

- To stabilize IV sites on delicate veins and limbs
- Malleable stays offer several positioning options
- Removable hook and loop straps eliminate the need for tape
- Padded for baby's comfort
- Not made with natural rubber latex
- Non-Sterile

Product #	Description	Qty
M8125-C	Child, 2" x 7¼"	30/Cs
M8125-I	Infant, 1½" x 3"	30/Cs
M8125-A	Adolescent, 4" x 9"	25/Cs



### Foam IV Boards

- Three convenient sizes
- Small metal stay contours easily to fragile limbs
- Tape application to ease the tension to infant's skin
- Not made with natural rubber latex
- Non-Sterile

Product #	Description	Qty
72-6100	Small, 2" x ¾"	100/Cs
72-6101	Medium, 3" x ¾"	100/Cs
72-6103	X-Large, 6" x 1½"	12/Cs



# Labor and Delivery

## Footprinters

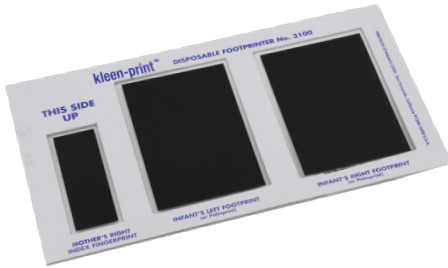

### Neet Feet™ Footprinter

- No mess or clean-up time
- Footprinting in one easy step
- Special tri-windowed printing surface for both baby's feet and mother's thumb
- No special paper needed
- Not made with natural rubber latex
- Non-sterile

**Product #** 5950      **Qty** 25/Bx



### Print-A-Foot™ Rigid Footprinter

- Easy, convenient handling for accurate prints
- Rigid plastic design for maximum stability and pressure
- Comes neatly stacked in dispenser box
- Not made with natural rubber latex
- Non-sterile

**Product #** 6950      **Qty** 25/Bx, 4 Bxs/Cs

### Circumcision Drape

- Center-cut fenestration is sewn, so edges will not fray and obstruct procedures
- Eliminates need for multiple towels, saving time and money
- Prewashed so it is soft and lint free
- Made from high quality blue cotton disposable OR towel
- Not made with natural rubber latex
- Sterile

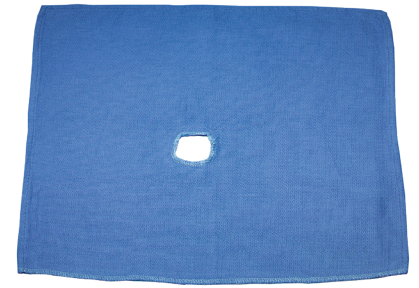

Product #	Description	Qty
70-104	17" x 13" w/ 1½" Fenestration	40/Cs

### Circumcision Straps

- Used to restrain infant's extremities during procedure
- Straps are easily affixed to circumcision or "papoose" boards with hook and loop
- Soft hook and loop receivable material for secure fit and baby's comfort
- Disposable
- Not made with natural rubber latex
- Non-sterile



Product #	Description	Qty
M1131	Circumcision Straps	20/Cs



# Labor and Delivery

## Circumcision Products



## Add-A-Clamp Circumcision Trays

- All items included for procedure
- Eliminates risk of cross-contamination
- Kit does not include disposable clamp
- Sterile packaging
- Not made with natural rubber latex

Product #	Description	Qty
50-5610	Add-A-Clamp Kit	30 Trays/Cs

### Kit includes:

Circumcision Drape w/1½" Fenestration, 1/Ea	Safety Pins, 2/Ea
PVP Paint, 0.75 oz Pouch, 1/Ea	Gauze, 3" x 3", 12-Ply, 10/Ea
Petroleum Gauze Dressing, 1/Ea	2 oz Medicine Cup, 1/Ea
6" Herwig Probe, 1/Ea	OR Towel, 1/Ea
4¾" Adson Forcep, 1/Ea	Safety Scalpel, #10 Blade, 1/Ea
5½" Scissors, 1/Ea	5" Curved Halstead Forceps, 1/Ea
5" Straight Halstead Forceps, 3/Ea	Half Shallow Tray, 9.7" x 5.4" , 1/Ea

### ™ & ® Products

Circon is a trademark of Circon Corp.  
Clear Grip is a trademark of DeRoyal Industries, Inc.  
Coban is a trademark of 3M Corporation.  
Crystalline is a registered trademark of DeRoyal Industries, Inc.  
DeBlade is a trademark of DeRoyal Industries, Inc.  
DeFogger is a trademark of DeRoyal Industries, Inc.  
DeRoyal is a registered trademark of DeRoyal Industries, Inc.  
da Vinci is a registered trademark of Intuitive Surgical Operations, Inc.  
Drain-Jug is a trademark of DeRoyal Industries, Inc.  
Dyonics is a registered trademark of Smith & Nephew, Inc.  
ExtendEVAC is a registered trademark of DeRoyal Industries, Inc.  
Fish Stick is a trademark of DeRoyal Industries, Inc.  
FlexiPad is a trademark of DeRoyal Industries, Inc.  
Grab Bag is a trademark of DeRoyal Industries, Inc.  
Hana is a registered trademark of Mizuho OSI Orthopedic Systems, Inc.  
H2NO is a registered trademark of DeRoyal Industries, Inc.  
Hewlett Packard is a registered trademark of HP Hewlett Packard Group LLC  
Hill-Rom is a registered trademark of Hill-Rom Services, Inc.  
HP is a registered trademark of HP Hewlett Packard Group LLC  
Karl Storz is a trademark of Karl Storz GmbH & Co. KG  
Linvatec is a registered trademark of CONMED Corporation.  
Loctite is a registered trademark of Henkel IP & Holding GMBH  
Mindray is a registered trademark of Shenzhen Mindray Bio-Medical Electronics Co. Ltd.  
Neet Feet is a trademark of DeRoyal Industries, Inc.  
Olympus is a registered trademark of Olympus Corporation.  
Omni-Jugs is a registered trademark of DeRoyal Industries, Inc.  
Print-A-Foot is a trademark of DeRoyal Industries, Inc.  
ProShield is a trademark of DeRoyal Industries, Inc.  
Puddle Guppy is a registered trademark of DeRoyal Industries, Inc.  
Richard Wolf is a trademark of Richard Wolf GmbH.  
Safe Cord is a trademark of Flagship Surgical, LLC.  
SafELiner is a registered trademark of DeRoyal Industries, Inc.  
Saf-T-Glove is a trademark of DeRoyal Industries, Inc.  
Saf-T-Ledge is a trademark of DeRoyal Industries, Inc.  
Sensostrip is a trademark of DeRoyal Industries, Inc.  
SharpStop is a trademark of DeRoyal Industries, Inc.  
Siemens is a registered trademark of Siemens Trademark GmbH & Co.  
Sof-Rol is a registered trademark of BSN Medical, Inc.  
SPEyes is a trademark of DeRoyal Industries, Inc.  
Snowden-Pencer is a registered trademark of Becton, Dickinson and Company.  
Specialist is a registered trademark of Essity.  
Steep-T is a registered trademark of DeRoyal Industries, Inc.  
Stryker is a registered trademark of Stryker Corporation.  
SurgiClick is a registered trademark of DeRoyal Industries, Inc.  
SutureClose is a trademark of DeRoyal Industries, Inc.  
Temple Touch Pro is a trademark of Medisim LTD  
The DeRoyal logo is a registered trademark of DeRoyal Industries, Inc.  
The Mini Mat is a trademark of Flagship Surgical, LLC.  
The Premium Solidifier+ logo is a trademark of DiSorb Systems, Inc.  
The Smooth Mat is a trademark of Flagship Surgical, LLC.  
The Surgical Mat is a trademark of Flagship Surgical, LLC.  
TroClean is a trademark of DeRoyal Industries, Inc.  
Umbilicup is a trademark of DeRoyal Industries, Inc.

# Index

## Product # Index

1-136.....	74	25-0802.....	103	28-0210.....	58	30-044.....	68
1-150.....	74	25-0803.....	103	28-0211.....	58	30-045.....	71
1-1818.....	73	25-1104.....	104	28-0212.....	58	30-048.....	71
1-1836-5.....	73	25-1108.....	104	28-0212H.....	58	30-049.....	65
1-230.....	74	25-1401.....	104	28-0213.....	58	30-049-10.....	65
1-237.....	74	25-1403.....	104	28-0214.....	58	30-049-6.....	65
1-250.....	74	25-1502.....	104	28-0216.....	58	30-049-P5.....	65
1-272.....	74	25-1701.....	104	28-0217.....	58	30-051.....	71
1-418.....	73	25-1702.....	104	28-0223.....	58	30-052.....	71
1-424.....	74	25-1801.....	104	28-0224.....	58	30-054.....	72
1-436.....	74	25-201.....	85	28-0225.....	58	30-055.....	72
1-472.....	74	25-2444.....	106	28-0226.....	58	30-056.....	72
1-8108.....	73	25-2244NS.....	106	28-0401.....	63	30-057.....	72
1-836.....	73	25-2244V.....	106	28-0401.....	89	30-058.....	72
200-1212.....	73	25-3001.....	80	28-0402.....	63	30-059.....	72
200-1818.....	73	25-3001C.....	80	28-0402.....	89	30-060.....	72
200-1818R.....	73	25-3002.....	80	28-0601.....	59	30-0602.....	93
200-418.....	73	25-3003.....	80	28-0602.....	59	30-061.....	72
200-418R.....	73	25-302.....	85	28-0611.....	59	30-063.....	72
23-201.....	102	25-303.....	60	28-0612.....	59	30-067.....	72
23-005.....	101	25-303.....	85	28-0701.....	65	30-068.....	72
23-201.....	101	25-303NS.....	60	28-0704.....	65	30-069.....	72
23-300.....	102	25-500.....	75	28-0801.....	61	30-072.....	72
23-310.....	102	25-501.....	75	28-0802.....	61	30-096.....	71
23-500.....	101	25-551.....	75	28-0804.....	61	30-1002.....	6
23-501.....	101	26-001.....	82	28-1001.....	61	30-1002.....	86
23-502.....	101	26-001PR.....	82	28-1002.....	61	30-1003.....	6
23-504.....	101	26-002.....	82	28-BTD05.....	61	30-1003.....	86
23-505.....	101	26-003.....	82	30-006M.....	88	30-101.....	67
23-506.....	101	26-003PR.....	82	30-010.....	66	30-106.....	66
23-507.....	101	26-004.....	82	30-0101.....	90	30-112.....	66
23-600.....	102	26-005.....	82	30-0102.....	90	30-115.....	67
23-701.....	101	26-005PR.....	82	30-0103.....	91	30-122.....	69
23-702.....	101	26-005PRNS.....	82	30-0104.....	91	30-154.....	72
25-001.....	84	26-006.....	82	30-018.....	69	30-176.....	70
25-002.....	84	26-011.....	79	30-0201.....	88	30-194.....	95
25-003.....	84	26-012.....	79	30-0202.....	88	30-195.....	95
25-004.....	84	26-013.....	79	30-0204.....	88	30-196.....	95
25-0101.....	103	26-017NS.....	81	30-0209.....	88	30-197.....	95
25-0103.....	103	26-018NS.....	81	30-022.....	69	30-198.....	95
25-0104.....	103	26-018PRNS.....	81	30-024.....	69	30-199.....	95
25-0105.....	103	26-019.....	81	30-025.....	69	30-200.....	56
25-0108.....	103	26-019NS.....	81	30-026.....	69	30-202.....	66
25-0108W.....	103	26-020.....	81	30-030.....	70	30-222.....	69
25-011.....	84	26-021.....	79	30-0301NS.....	94	30-226.....	97
25-012.....	84	26-022.....	79	30-031.....	70	30-226NS.....	97
25-012NS.....	84	26-022B.....	79	30-032.....	70	30-227.....	97
25-0201.....	103	26-023.....	79	30-033.....	70	30-227NS.....	97
25-0301.....	103	28-0001.....	59	30-034.....	70	30-228.....	97
25-0401.....	103	28-0101.....	62	30-035.....	70	30-228NS.....	97
25-0402.....	103	28-0101B.....	62	30-036.....	68	30-245.....	97
25-0403.....	103	28-0102.....	62	30-037.....	68	30-245NS.....	97
25-0501.....	103	28-0102B.....	62	30-038.....	68	30-300.....	72
25-0502.....	103	28-0201.....	58	30-039.....	68	30-301.....	72
25-0504.....	103	28-0202.....	58	30-040.....	68	30-302.....	72
25-0701.....	103	28-0203.....	59	30-041.....	68	30-303.....	72
25-0702.....	103	28-0207.....	58	30-042.....	68	30-304.....	72
25-0801.....	103	28-0209.....	58	30-043.....	68	30-305.....	72

30-305K.....	60	30-900NS.....	86	5036-30.....	21	70-150.....	77
30-306.....	72	30-901.....	86	5036-31.....	21	71-0500.....	20
30-307.....	72	30-902.....	86	5036-35.....	21	71-0800.....	14
30-319.....	97	31-090.....	70	50-5610.....	122	71-1000.....	20
30-319NS.....	97	31-207.....	71	54-1665R.....	115	71-1000BR.....	13
30-320.....	97	31-251.....	113	54-1680R.....	115	71-1000BR.....	26
30-320NS.....	97	31-807.....	69	54-2450R.....	115	71-1000BRB.....	13
30-321.....	97	32-082.....	77	54-2480R.....	115	71-1000DS.....	13
30-321NS.....	97	32-1029.....	109	54-3650R.....	115	71-1000DS.....	26
30-322.....	97	32-1328.....	112	54-3665R.....	115	71-1000DSB.....	13
30-322NS.....	97	32-1328NT.....	112	54-5001.....	114	71-1000S.....	20
30-325.....	97	32-1335NS.....	112	54-5005.....	114	71-1000T.....	26
30-325NS.....	97	32-1336NS.....	112	54-5010.....	114	71-1116.....	27
30-326.....	97	32-1385NS.....	94	54-5020.....	114	71-1117.....	26
30-326NS.....	97	32-1386NS.....	94	54-5030.....	114	71-1118.....	19
30-327.....	97	32-1746.....	99	54-5060.....	114	71-1119.....	26
30-327NS.....	97	32-1796.....	99	54-5115R.....	115	71-1122.....	25
30-328.....	97	32-200.....	56	54-5136R.....	115	71-1123.....	25
30-328NS.....	97	32-345.....	82	54-7062.....	114	71-1124.....	25
30-402.....	95	32-525.....	99	54-7066.....	114	71-1142.....	25
30-403.....	95	32-526.....	99	54-7069.....	114	71-1165.....	25
30-404.....	95	32-665.....	95	54-8115R.....	115	71-1200.....	20
30-406.....	95	32-881.....	109	54-8142R.....	115	71-1500.....	20
30-409.....	113	32-998.....	77	59-0802.....	111	71-1500BR.....	13
30-410.....	113	34-101.....	64	59-0803NS.....	111	71-1500BR.....	26
30-419.....	71	34-102.....	64	59-0806.....	111	71-1500BRB.....	13
30-422.....	95	34-103.....	64	59-0900NS.....	111	71-1500DS.....	13
30-423.....	95	34-104.....	64	5950.....	120	71-1500DS.....	26
30-424.....	95	34-105.....	64	60-101.....	76	71-1500DSB.....	13
30-426.....	95	34-106.....	64	60-102.....	76	71-1500S.....	20
30-5510.....	93	34-107.....	64	60-103.....	76	71-1500T.....	26
30-701.....	83	34-201.....	64	60-106.....	76	71-18000.....	20
30-701NS.....	83	34-202.....	64	6036-00.....	15	71-2005.....	20
30-702.....	83	34-302.....	64	63-100.....	76	71-2063.....	25
30-702NS.....	83	34-401.....	64	63-101.....	76	71-2066.....	25
30-703.....	83	34-402.....	64	63-102.....	76	71-2082.....	25
30-703NS.....	83	34-501.....	65	63-103.....	76	71-2083.....	25
30-704.....	83	34-506.....	65	63-106.....	76	71-2084.....	25
30-704NS.....	83	35-304.....	95	63-108.....	76	71-2085.....	25
30-705.....	83	35-309.....	95	63-110.....	76	71-2086.....	25
30-706.....	83	35-309NS.....	95	63-200.....	76	71-2096.....	26
30-711.....	78	35-312.....	95	63-201.....	76	71-2098.....	26
30-712.....	78	35-404.....	95	63-203.....	76	71-3000.....	20
30-713.....	78	35-409.....	95	63-206.....	76	71-3000BR.....	13
30-714.....	78	35-409NS.....	95	63-207.....	76	71-3000BR.....	26
30-721.....	78	35-412.....	95	68-103.....	77	71-3000BRB.....	13
30-722.....	78	35-412NS.....	95	68-106.....	77	71-3000S.....	20
30-723.....	78	35-604.....	95	68-108.....	77	71-3000T.....	26
30-724.....	78	35-609.....	95	6833.....	113	71-4301.....	22
30-731.....	78	35-609NS.....	95	6833-B.....	113	71-4301L.....	22
30-732.....	78	35-612.....	95	6833NS.....	113	71-4302.....	22
30-733.....	78	35-612NS.....	95	68-401.....	77	71-4302L.....	22
30-734.....	78	3702D02.....	38	68-402.....	77	71-4304.....	22
30-741.....	78	5036-00.....	15	68-406.....	77	71-4305.....	22
30-742.....	78	5036-01.....	15	68-408.....	77	71-4306.....	22
30-743.....	78	5036-05.....	15	6950.....	120	71-4311.....	24
30-744.....	78	5036-10.....	15	70-103.....	77	71-4312.....	23
30-802.....	86	5036-10.....	15	70-104.....	121	71-4313.....	23

# Index

## Product # Index

71-5003.....	26	71-C706.....	16	81-0100BX.....	8	88-000003.....	53
71-5008.....	26	71-C710.....	16	81-010400.....	8	88-000004.....	53
71-5009.....	26	71-C7100NS.....	16	81-010700.....	8	88-000006.....	53
71-5010.....	26	71-C712.....	16	81-020409.....	4	88-000007.....	53
71-5012.....	26	71-C720.....	16	81-020412.....	4	88-000008.....	53
71-5013.....	27	71-D860.....	17	81-020709.....	4	88-000010.....	54
71-5014.....	26	71-D861.....	17	81-025400.....	4	88-000011.....	54
71-5016.....	27	71-D861V.....	17	81-025409.....	4	88-000011C.....	54
71-5017.....	26	71-D862.....	17	81-025409.....	4	88-000012.....	54
71-5018.....	26	71-D871.....	17	81-025412.....	4	88-000012C.....	54
71-5019.....	26	71-D872.....	17	81-030408.....	7	88-000013.....	54
71-5020.....	26	71-D873.....	17	81-030415.....	7	88-000013C.....	54
71-5045.....	27	71-D8770.....	17	81-030418.....	7	88-000015C.....	54
71-5045-8.....	27	71-D880.....	18	81-030430.....	7	88-000021.....	53
71-5045-8R.....	27	71-D882.....	18	81-040409.....	3	88-000022.....	53
71-5045R.....	27	71-D883A.....	18	81-040412.....	3	88-000031.....	53
71-5045R-S.....	27	71-D884.....	18	81-040418.....	3	88-000032.....	53
71-5046.....	26	71-D885.....	18	81-040424.....	3	88-000041.....	53
71-5047.....	26	71-D886.....	18	81-040709.....	3	88-000042.....	53
71-515N.....	19	71-D886V.....	18	81-040712.....	3	88-000051.....	53
71-515S.....	19	71-D887.....	18	81-040718.....	3	88-000052.....	53
71-5912.....	26	71-D887V.....	18	81-044418.....	3	88-000102.....	55
71-5915.....	26	71-D888.....	18	81-050409.....	3	88-000201.....	55
71-616N.....	19	72-3101.....	116	81-050412.....	3	88-000202.....	55
71-616S.....	19	72-3102.....	116	81-050418.....	3	88-000222.....	53
71-618N.....	19	72-3103.....	116	81-050424.....	3	88-000702.....	57
71-618S.....	19	72-3104.....	116	81-050718.....	3	88-000722.....	57
71-619N.....	19	72-3105.....	116	81-080408.....	5	88-000725.....	57
71-619S.....	19	72-3122.....	116	81-080410.....	5	88-000M10C.....	54
71-6516.....	13	72-3123.....	116	81-080412.....	5	88-000M11.....	54
71-6517.....	13	72-3124.....	116	81-080414.....	5	88-000M11C.....	54
71-6526.....	13	72-3125.....	116	81-080416.....	5	88-000M12.....	54
71-6527.....	13	72-4100.....	117	81-080418.....	5	88-000M12C.....	54
71-6529.....	13	72-4101.....	117	81-080500.....	6	88-000M13.....	54
71-6539.....	13	72-4102.....	117	81-080514.....	6	88-000M13C.....	54
71-7101.....	14	72-6100.....	119	81-080516.....	6	88-001000.....	56
71-8002.....	14	72-6101.....	119	81-080518.....	6	88-001501.....	53
71-8003.....	14	72-6103.....	119	81-090400.....	7	88-001502.....	53
71-8004.....	14	72-7000.....	113	81-090401.....	7	88-001521.....	53
71-8005.....	14	72-7000B.....	113	81-1010HP.....	2	88-015722.....	57
71-8009.....	14	72-7100.....	110	81-1010MR.....	2	88-1010502.....	53
71-8010.....	14	72-8000.....	110	81-1010SM.....	2	88-103.....	54
71-8011.....	14	77-100012.....	92	81-101400.....	2	88-104.....	55
71-8012.....	14	77-100013.....	92	81-101700.....	2	88-104A.....	54
71-8013.....	14	77-100025.....	92	81-1020400.....	1	88-1510.....	54
71-8100RNS.....	25	77-103020T.....	92	81-1020BKT.....	1	88-1512.....	54
71-9000.....	20	77-103030T.....	92	81-1020HP.....	1	88-2505-10FR.....	53
71-C501.....	16	77-103036T.....	92	81-1020MR.....	1	88-2510.....	54
71-C506.....	16	77-103620T.....	92	81-1020PC.....	1	88-2512.....	54
71-C510.....	16	77-103630T.....	92	81-1020REF.....	1	88-2610.....	54
71-C5100NS.....	16	77-103636T.....	92	81-1020SCU.....	1	89-5014.....	106
71-C512.....	16	77-103640T.....	92	81-1020SEC.....	1	89-5032.....	100
71-C520.....	16	77-104030T.....	92	81-1020SL.....	1	89-5041.....	99
71-C606.....	16	77-104040T.....	92	81-1020SM.....	1	89-5043.....	108
71-C610.....	16	77-104060T.....	92	81-1020SU.....	1	89-5044.....	107
71-C6100NS.....	16	81-010000.....	8	81-1020TTP.....	1	9-1212.....	73
71-C612.....	16	81-010001.....	8	88-000001.....	53	9-1818.....	73
71-C620.....	16	81-010003.....	8	88-000002.....	53	9219-00.....	41

9219-01.....	41	9704-48.....	98	D4515NS.....	105	M10-312.....	34
9219-02.....	41	9704-48NS.....	98	D4516.....	105	M10-314.....	34
9219-03.....	41	9706-48.....	98	D4520.....	105	M10-315.....	34
9262-00.....	34	9706-60.....	98	D4520NS.....	105	M10-315-36.....	34
9408-38.....	97	9706-72NS.....	98	D4521.....	105	M10-319.....	33
9409-54.....	97	9708-60.....	98	D4521NS.....	105	M10-319E.....	33
9412-54.....	97	9708-72.....	98	D4522.....	105	M10-321.....	42
9416-54.....	97	9710-25.....	96	D4522NS.....	105	M10-323.....	34
9-418.....	73	9710-25NS.....	96	D4524.....	105	M10-323C.....	34
9502-36.....	98	9710-35.....	96	D4524NS.....	105	M10-323E.....	34
9503-36.....	98	9710-45.....	96	D45E11.....	105	M10-324.....	34
9503-54.....	98	9710-45NS.....	96	D6200.....	104	M10-325.....	34
9504-36.....	98	9710-65.....	96	D6200NS.....	104	M10-328.....	34
9504-36NS.....	98	9710-65NS.....	96	FNICU-25.....	11	M1131.....	121
9504-48.....	98	9810-25.....	96	FNICU-26.....	11	M1132-10.....	109
9504-48NS.....	98	9810-35.....	96	FNICU-35.....	11	M1140.....	109
9504-60.....	98	9810-45.....	96	FNICU-36.....	11	M1143.....	109
9506-36.....	98	9810-65.....	96	FNICU-37.....	9	M15-2072R.....	44
9506-48.....	98	9811-25.....	96	FNICU-37.....	11	M15-2074.....	44
9506-60.....	98	9811-35.....	96	H2NO.....	21	M15-2075.....	44
9506-60NS.....	98	9811-45.....	96	HNICU-00.....	12	M15-2076.....	44
9506-72.....	98	9811-65.....	96	HNICU-01.....	12	M15-2077.....	44
9508-48.....	98	9812-610.....	96	HNICU-02.....	12	M3020-4.....	37
9508-60.....	98	9812-610NS.....	96	HNICU-03.....	12	M3020-6.....	37
9508-72.....	98	9816-36.....	97	HNICU-04.....	12	M30-640.....	45
9510-48.....	98	9816-54.....	97	HNICU-05.....	12	M4212D04.....	44
9510-60.....	98	9816-54NS.....	97	HNICU-100.....	118	M5131.....	44
9600-030A-10D.....	63	9818-54.....	97	HNICU-200.....	118	M5173.....	42
9600-030A-50D.....	63	9818-54NS.....	97	HNICU-22.....	10	M5175.....	43
9600-036A-10D.....	63	9825-00.....	96	HNICU-25.....	10	M5178.....	43
9600-036A-50D.....	63	9825-00NS.....	96	HNICU-26.....	10	M5179.....	44
9600-048A-10D.....	63	9825-09.....	96	HNICU-32.....	10	M5180.....	43
9600-048A-50D.....	63	9835-00.....	96	HNICU-33.....	10	M5182.....	42
9600-BP10D.....	63	9835-00NS.....	96	HNICU-35.....	10	M5183.....	42
9600-BU10D.....	63	9835-09.....	96	HNICU-36.....	10	M60-015.....	35
9600-CW03D.....	63	9845-00.....	96	HNICU-37.....	9	M60-015A.....	35
9600-SD06D.....	63	9845-00NS.....	96	HNICU-37.....	10	M60-015B.....	35
9602-36.....	98	9845-09.....	96	HNICU-38.....	10	M60-018.....	37
9603-36.....	98	9845-10.....	96	HNICU-39.....	10	M60-023.....	30
9604-36.....	98	9865-00.....	96	JLC-3NS.....	87	M60-023-C.....	30
9604-36NS.....	98	9865-00NS.....	96	JPC-3NS.....	87	M60-023W.....	30
9604-48.....	98	9865-09.....	96	KW-30-5200.....	53	M60-024-L.....	38
9604-48NS.....	98	9865-10.....	96	M10-049.....	42	M60-024-M.....	38
9604-60.....	98	9865-10NS.....	96	M10-071.....	36	M60-024-S.....	38
9606-48.....	98	9977-09.....	97	M10-073.....	36	M60-025-L.....	39
9606-54.....	98	9977-09NS.....	97	M10-082.....	32	M60-025-M.....	39
9606-54NS.....	98	9978-06.....	97	M10-083E.....	45	M60-025-S.....	39
9606-60.....	98	9978-09.....	97	M10-090.....	30	M60-028.....	32
9606-60NS.....	98	9978-12.....	97	M10-091.....	30	M60-030.....	31
9606-72.....	98	9978-16.....	97	M10-091E.....	30	M60-031.....	45
9606-72NS.....	98	AM3611.....	79	M10-091F.....	30	M60-031-L.....	40
9608-48.....	98	AM3612.....	79	M10-091W.....	30	M60-031-M.....	40
9608-60.....	98	AM3613.....	79	M10-092.....	30	M60-031-S.....	40
9608-72.....	98	D4510.....	105	M10-092B.....	30	M60-032.....	45
9608-72NS.....	98	D4510NS.....	105	M10-092E.....	30	M60-032A.....	45
9610-48.....	98	D4511.....	105	M10-093.....	41	M60-032B.....	45
9704-36.....	98	D4515.....	105	M10-094.....	41	M60-032D.....	45
9704-36NS.....	98	D4515C.....	105	M10-095.....	41	M60-032E.....	45

# Index

## Product # Index

M60-033 .....	45	M9352-D .....	43
M60-034 .....	34	M9500 .....	33
M60-044 .....	36	M9500E .....	33
M60-045 .....	37	M9501 .....	30
M60-049 .....	36	M9501E .....	30
M60-061E .....	45	M9503 .....	31
M60-063 .....	45	M9504 .....	31
M60-070 .....	35	M9504E .....	31
M60-070E .....	35	M9505 .....	31
M60-070L .....	40	NI-25 .....	11
M60-070M .....	40	NI-26 .....	11
M60-073-L .....	39	NI-35 .....	11
M60-073-M .....	39	NI-36 .....	11
M60-073-S .....	39	NI-37 .....	9
M60-074 .....	39	NI-37 .....	11
M60-075 .....	39	PHESL-1000B .....	13
M60-076EL .....	38	PHESL-1500B .....	13
M60-076EM .....	38	PHESL-3000B .....	13
M60-076ES .....	38	TM500D .....	62
M60-076-L .....	38	TSR-1 .....	80
M60-076-M .....	38	USA-010D .....	23
M60-076-S .....	38	USA-A10D .....	23
M60-076-XS .....	38	USA-S10D .....	24
M60-078-L .....	38		
M60-078-M .....	38		
M60-078-S .....	38		
M60-224 .....	40		
M60-230 .....	45		
M60-251 .....	32		
M60-318 .....	49		
M60-319 .....	49		
M60-325 .....	52		
M60-331 .....	48		
M60-334 .....	52		
M60-336 .....	50		
M60-337 .....	50		
M60-339 .....	50		
M60-340 .....	49		
M60-341 .....	51		
M60-342 .....	33		
M60-345 .....	51		
M60-346 .....	50		
M60-347 .....	51		
M60-348 .....	51		
M60-350 .....	52		
M60-355 .....	50		
M60-360 .....	49		
M60-361 .....	48		
M60-374 .....	48		
M60-SF500 .....	46		
M60-SF501 .....	46		
M60-SF502 .....	46		
M60-SF503 .....	47		
M60-SF505 .....	47		
M60-SF510F .....	47		
M8125-A .....	119		
M8125-C .....	119		
M8125-I .....	119		







DeRoyal Industries, Inc.  
200 DeBusk Lane, Powell, TN 37849 USA  
888.938.7828 | [deroyal.com](http://deroyal.com)